

Solenoid Operated Directional Valves, DSG-005 Series

These DSG-005 series solenoid directional valves are the products newly developed as a “Mini-series”. Compared with DSG-01 series, the valve are much more compactly manufactured but enjoy a maximum operating pressure of 25 MPa (3630 PSI) and a maximum flow rate of 15 L/min (3.96 U.S.GPM), while contributing further to a space saving requirement. Moreover, using wet armature solenoids, the valves ensure the long life.

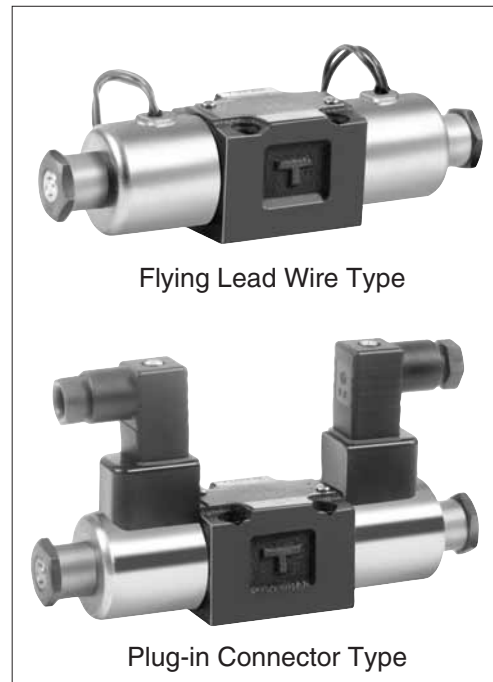
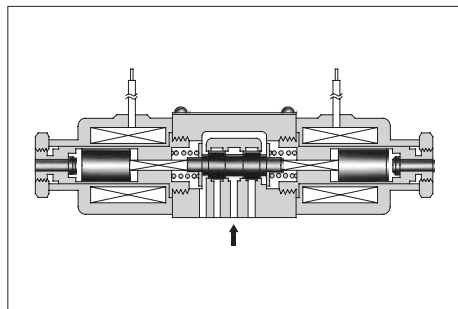

Specifications

Model Numbers	Max. Flow [★] L/min (U.S.GPM)	Max. Operating Pressure MPa (PSI)	Max. Tank-Line Back Pressure MPa (PSI)	Max. Changeover Frequency min ⁻¹ (Cycles/min)	Approx. Mass kg (lbs.)
DSG-005-3C*- *-40/4090	15 (3.96)	25 (3630)	7 (1020)	120	0.5 (1.1)
DSG-005-2B*- *-40/4090					0.4 (.9)

★ The maximum flow means the limited flow without inducing any abnormality to the operation (changeover) of the valve. The maximum flow differs according to the type and operating conditions. For details, please refer to the “List of Standard Models and Maximum Flow” on pages 338 to 339.

Solenoid Rating

Electric Source	Coil Type	Frequency (Hz)	Voltage (V)		Current & Power at Rated Voltage		
			Source Rating	Serviceable	Inrush ^{★1} (A)	Holding (A)	Power (W)
AC	A100	50	100	80 – 110	0.36	0.16	—
		60		90 – 120	0.34	0.11	
	A200	50	200	160 – 220	0.18	0.08	
		60		180 – 240	0.17	0.05	
DC ^{★2}	D12	—	12	10.8 – 13.2	—	1.2	15
	D24	—	24	21.6 – 26.4		0.6	

★1 Inrush current in the above table shows rms values at maximum stroke.

★2 The Plug-in Connector Type DC solenoid has a built-in surge absorber. The Flying Lead Wire Type has no surge absorber equipped. Install a surge absorber separately.

Model Number Designation

F-	DSG	-005	-3	C	2	-D24	-N	-40	*
Special Seals	Series Number	Valve Size	Number of Valve Position	Spool-Spring Arrangement	Spool Type	Coil Type	Electrical Conduit Connection	Design Number	Design Standard
F: Special Seals for Phosphate Ester Type Fluids (Omit if not required)	DSG: Solenoid Operated Directional Valve	005	3	C: Spring Centred	2, 3 40	AC A100, A200 DC D12, D24	None: Flying Lead Wire Type N: Plug-in Connector Type N1: Plug-in Connector with Indicator Light	40	Refer to [★]
			2	B: Spring Offset	2, 3				

★ Design Standards: None Japanese Standard "JIS" and European Design Standard 90 N. American Design Standard

Sub-plates

Piping Size	Japanese Standard "JIS"		European Design Standard		N. American Design Standard		Approx. Mass kg (lbs.)
	Sub-plate Model Numbers	Thread Size	Sub-plate Model Numbers	Thread Size	Sub-plate Model Numbers	Thread Size	
1/8	DSGM-005X-20	Rc 1/8	DSGM-005X-2080	1/8 BSP.F	DSGM-005X-2090	1/8 NPT	0.8 (1.8)
1/4	DSGM-005Y-20	Rc 1/4	DSGM-005Y-2080	1/4 BSP.F	DSGM-005Y-2090	1/4 NPT	0.8 (1.8)

● Sub-plates are available. Specify the sub-plate model number from the table above. When sub-plates are not used, the mounting surface should have a good machined finish.

Mounting Bolts

Four socket head cap screws in the table below are included.

Descriptions	Soc. Hd. Cap Screw (4 Pcs.)	Tightening Torque
Japanese Standard "JIS" European Design Standard	M4 × 35 Lg.	2.5 - 3.5 Nm (22.1 - 31.0 in. lbs.)
N. American Design Standard	No. 8-32 UNC × 1-3/8 Lg.	

Typical Changeover Time (Example)

Changeover time varies according to oil viscosity, spool type and hydraulic circuit.

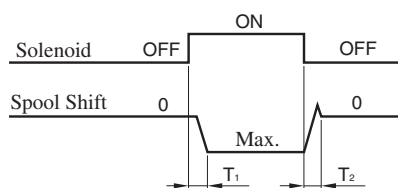

[Test Conditions]

Pressure: 16 MPa (2320 PSI)

Flow Rate: 7.5 L/min (1.98 U.S.GPM)

Viscosity: 30 mm²/s (141 SSU)

Voltage: Rated Voltage (After coil temperature rises and saturated)



Direction of Flow: P → A → B → T
P → B → A → T

[Result of Measurement]

Model Numbers	Time ms	
	T ₁	T ₂
DSG-005-3C2-A*	16	60
DSG-005-3C2-D*	23	40
DSG-005-2B2-A*	14	45
DSG-005-2B2-D*	15	33

■ List of Standard Models and The Maximum Flow

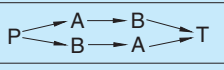
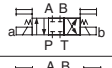

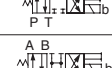
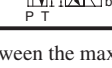
● Models with AC Solenoids : DSG-005-*** -A* -40/4090

No. of Valve Position	Spool-Spring Arrangement	Model Numbers	Graphic Symbols	Max. Flow L/min											
								P → A [Port "B" Blocked]				P → B [Port "A" Blocked]			
				Working Pressure MPa				Working Pressure MPa				Working Pressure MPa			
				5	10	16	25	5	10	16	25	5	10	16	25
Three Positions	Spring Centred	DSG-005-3C2		15	15	15	15	15(14)	15(7)	12(3)	4(0.5)	15(14)	15(7)	12(3)	4(0.5)
		DSG-005-3C3		12	12	12	12	15	15	15	15	15	15	15	15
		DSG-005-3C40		15	15	15	15	15(14)	15(6)	12(2)	4(0.5)	15(14)	15(6)	12(2)	4(0.5)
Two Positions	Spring Offset	DSG-005-2B2		14	14	14	14	2	1	1	1	15(14)	15(10)	13(5)	6(0.5)
		DSG-005-2B3		13.5	13.5	13.5	13.5	3	3	3	3	15	15(14)	15(11)	15(9)

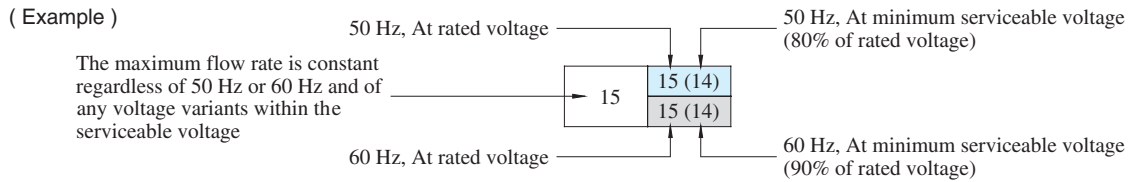
Notes: 1. The relation between the maximum flow in the table above and the frequency/voltage (within the serviceable voltage) is as shown below.

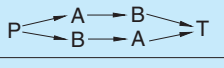
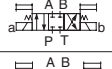

● Models with DC Solenoids : DSG-005-*** -D* -40/4090

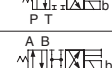
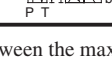
No. of Valve Position	Spool-Spring Arrangement	Model Numbers	Graphic Symbols	Max. Flow L/min											
								P → A [Port "B" Blocked]				P → B [Port "A" Blocked]			
				Working Pressure MPa				Working Pressure MPa				Working Pressure MPa			
				5	10	16	25	5	10	16	25	5	10	16	25
Three Positions	Spring Centred	DSG-005-3C2		15	15	15	15	15	8	5	3	15	8	5	3
		DSG-005-3C3		15	15	15	15	15	15	15	15	15	15	15	15
		DSG-005-3C40		15	15	15	15	15	13	8	5	15	13	8	5
Two Positions	Spring Offset	DSG-005-2B2		14	14	14	14	8.5	4.5	6.5	6.5	15	15	11	9
		DSG-005-2B3		13.5	13.5	13.5	13.5	8	7	8	9	15	15	15	13.5

Notes: 1. The relation between the maximum flow in the table above and the voltage (within the serviceable voltage) is as shown below.

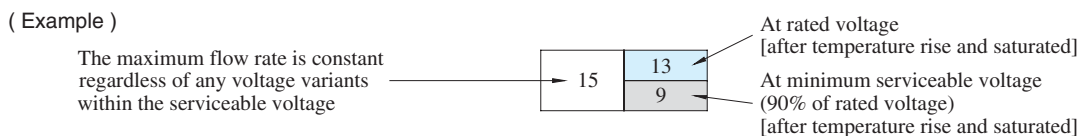

List of Standard Models and The Maximum Flow

Models with AC Solenoids : DSG-005-***-A*-40/4090

No. of Valve Position	Spool-Spring Arrangement	Model Numbers	Graphic Symbols	Max. Flow U.S.GPM											
				Working Pressure PSI				Working Pressure PSI				Working Pressure PSI			
				730	1450	2320	3630	730	1450	2320	3630	730	1450	2320	3630
Three Positions	Spring Centred	DSG-005-3C2		4.0	4.0	4.0	4.0	4.0(3.7)	4.0(1.9)	3.2(.8)	1.1(.1)	4.0(3.7)	4.0(1.9)	3.2(.8)	1.1(.1)
		DSG-005-3C3		3.2	3.2	3.2	3.2	4.0	4.0	4.0	4.0	4.0	4.0	4.0	4.0
		DSG-005-3C40		4.0	4.0	4.0	4.0	4.0(3.7)	4.0(1.6)	3.2(.5)	1.1(.1)	4.0(3.7)	4.0(1.6)	3.2(.5)	1.1(.1)
Two Positions	Spring Offset	DSG-005-2B2		3.7	3.7	3.7	3.7	.5	.3	.3	.3	4.0(3.7)	4.0(2.6)	3.4(1.3)	1.6(.1)
		DSG-005-2B3		3.6	3.6	3.6	3.6	.8	.8	.8	.8	4.0	4.0(3.7)	4.0(2.9)	4.0(2.4)

Notes: 1. The relation between the maximum flow in the table above and the frequency/voltage (within the serviceable voltage) is as shown below.

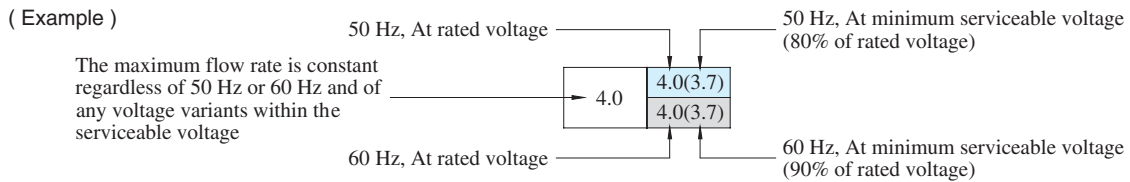

Models with DC Solenoids : DSG-005-***-D*-40/4090

No. of Valve Position	Spool-Spring Arrangement	Model Numbers	Graphic Symbols	Max. Flow U.S.GPM											
				Working Pressure PSI				Working Pressure PSI				Working Pressure PSI			
				730	1450	2320	3630	730	1450	2320	3630	730	1450	2320	3630
Three Positions	Spring Centred	DSG-005-3C2		4.0	4.0	4.0	4.0	4.0	2.1	1.3	.8	4.0	2.1	1.3	.8
		DSG-005-3C3		4.0	4.0	4.0	4.0	4.0	4.0	4.0	4.0	4.0	4.0	4.0	4.0
		DSG-005-3C40		4.0	4.0	4.0	4.0	4.0	3.4	2.1	1.3	4.0	3.4	2.1	1.3
Two Positions	Spring Offset	DSG-005-2B2		3.7	3.7	3.7	3.7	2.3	1.2	1.7	1.7	4.0	4.0	2.9	2.4
		DSG-005-2B3		3.6	3.6	3.6	3.6	2.1	1.9	2.1	2.4	4.0	4.0	4.0	3.6

Notes: 1. The relation between the maximum flow in the table above and the voltage (within the serviceable voltage) is as shown below.

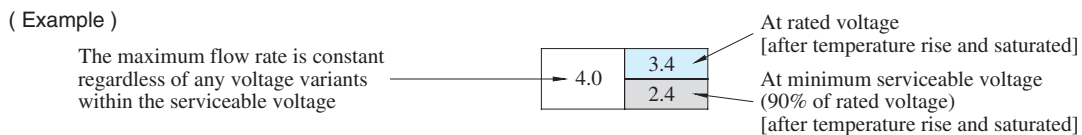

Pressure Drop

Pressure drop curves based on viscosity of 30 mm²/s (141 SSU) and specific gravity of 0.850.

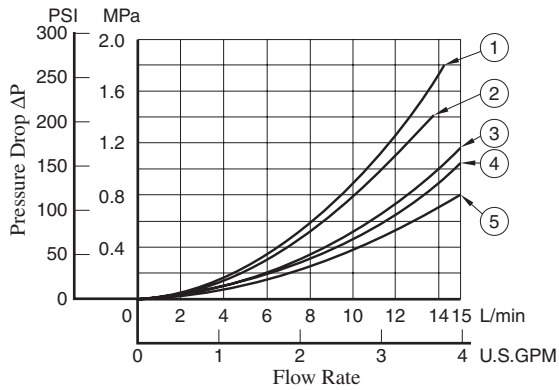

Model Numbers	Pressure Drop Curve Numbers				
	P → A	B → T	P → B	A → T	P → T
DSG-005-3C2	④	④	④	④	—
DSG-005-3C3	⑤	⑤	⑤	⑤	③
DSG-005-3C40	④	④	④	④	—
DSG-005-2B2	①	①	④	④	—
DSG-005-2B3	②	②	④	④	—

● For any other viscosity, multiply the factors in the table below.

Viscosity	mm ² /s	15	20	30	40	50	60	70	80	90	100
	SSU	77	98	141	186	232	278	324	371	417	464
Factor		0.84	0.91	1.00	1.07	1.14	1.19	1.24	1.28	1.32	1.35

● For any other specific gravity (G'), the pressure drop (ΔP) may be obtained from the formula below.

$$\Delta P' = \Delta P (G'/0.850)$$

Flying Lead Wire Type

- Spring Centred: DSG-005-3C* - $\frac{A^*}{D^*}$ -40/4090

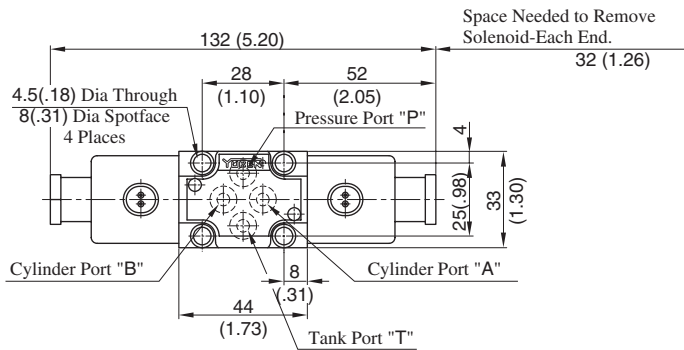

- Spring Offset: DSG-005-2B* - $\frac{A^*}{D^*}$ -40/4090

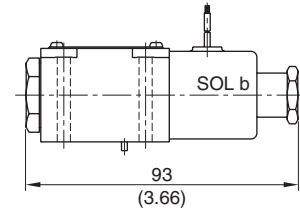

- For other dimensions, refer to "Spring Centred" type.

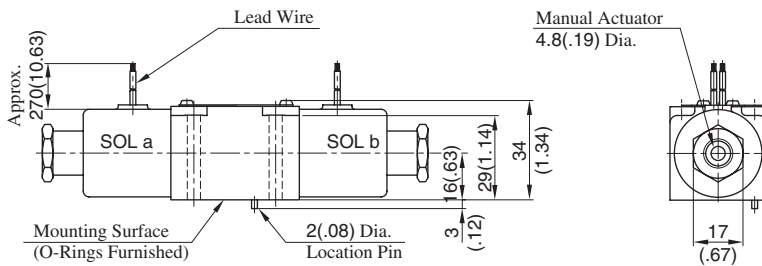

DIMENSIONS IN
MILLIMETRES (INCHES)

DIN Connector Type / DIN Connector with Indicator Light

- Spring Centred: DSG-005-3C* - $\frac{A^*}{D^*}$ -N/N1-40/4090
- Spring Offset: DSG-005-2B* - $\frac{A^*}{D^*}$ -N/N1-40/4090

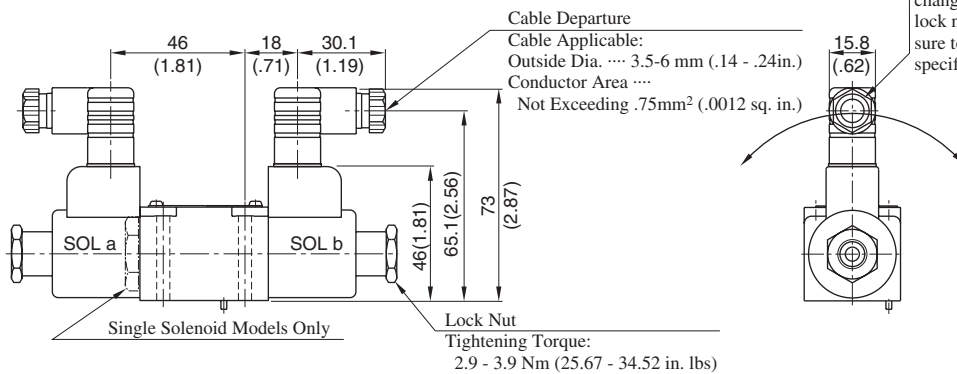

The position of the Plug-in connector can be changed as illustrated below by loosening the lock nut. After completion of the change, be sure to tighten the lock nut with the torque as specified below.

- For other dimensions, refer to "Flying Lead Wire Type".

E

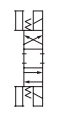

DSG-005 Series Solenoid
Operated Directional Valves

■ Sub-plates: DSGM-005* -20/2080/2090

DIMENSIONS IN
MILLIMETRES (INCHES)

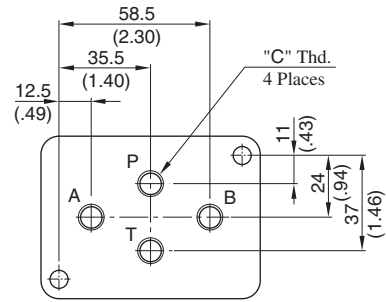
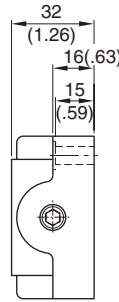
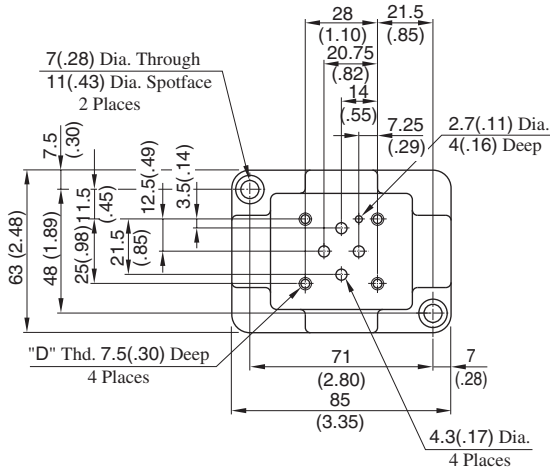

Sub-plate Model Numbers	Piping Size "C" Thd.	"D" Thd.
DSGM-005X-20	Rc 1/8	M4
DSGM-005X-2080	1/8 BSP. F	
DSGM-005X-2090	1/8 NPT	No. 8-32 UNC
DSGM-005Y-20	Rc 1/4	M4
DSGM-005Y-2080	1/4 BSP. F	
DSGM-005Y-2090	1/4 NPT	No. 8-32 UNC

■ List of Seals, Solenoid Ass'y, Coil and Connector Ass'y

DSG-005-***-*-40/4090

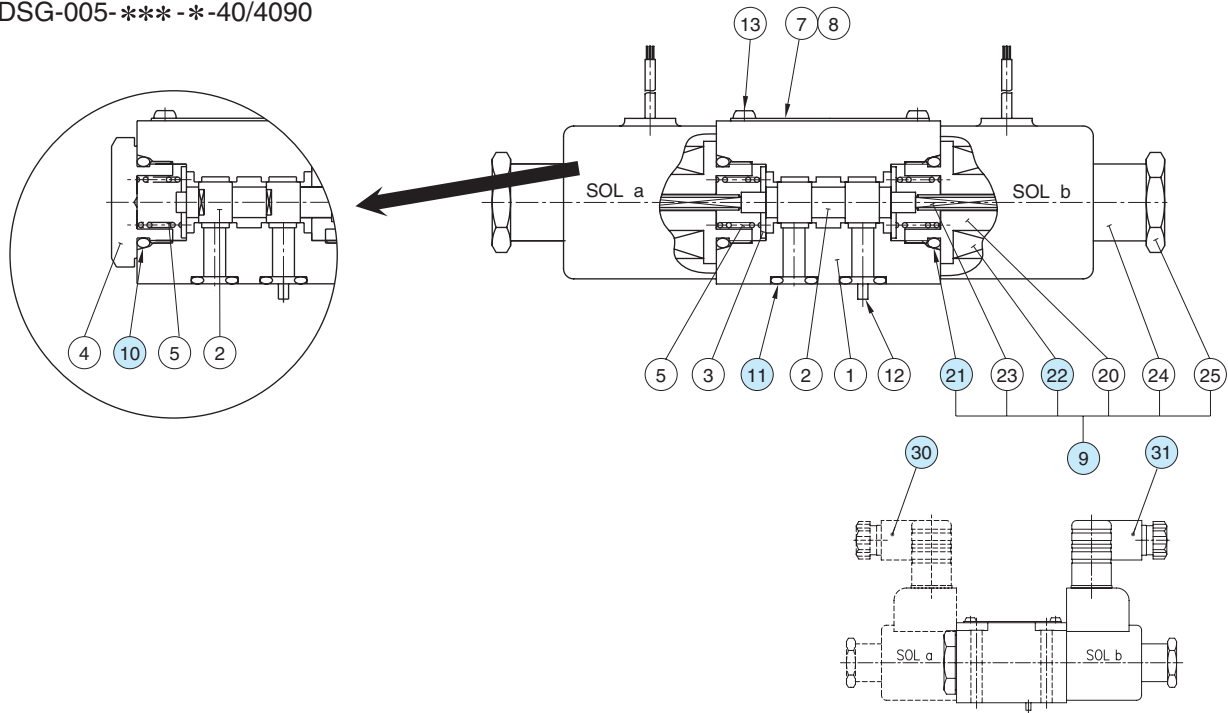

● List of Seals

Item	Name of Parts	Part Numbers	Qty.		Remarks
			3C*	2B*	
10	O-Ring	SO-NB-P14	—	1	
11	O-Ring	SO-NB-P6	4	4	
21	O-Ring	SO-NB-P14	2	1	Included in Solenoid Ass'y

Note: When ordering seals, please specify the seal kit number "KS-DSG-005-40".

■ Solenoid Ass'y, Coil and Connector Ass'y No.

Valve Model Number	⑨ Solenoid Ass'y No.	⑫ Coil No.	⑳ Connector Ass'y Part No.	㉑ Connector Ass'y Part No.	Remarks
DSG-005-***-A100	SA05-100-40	C-SA05-100-40	—	—	Flying Lead Wire Type
DSG-005-***-A200	SA05-200-40	C-SA05-200-40			
DSG-005-***-D12	SD05-12-40	C-SD05-12-40			
DSG-005-***-D24	SD-05-24-40	C-SD-05-24-40			
DSG-005-***-A100-N	SA05-100-N-40	C-SA05-100-N-40	TK290058-7	TK290058-7	Plug-in Connector Type
DSG-005-***-A200-N	SA05-200-N-40	C-SA05-200-N-40			
DSG-005-***-D12-N	SD05-12-N-40	C-SD05-12-N-40			
DSG-005-***-D24-N	SD-05-24-N-40	C-SD-05-24-N-40			
DSG-005-***-A100-N1	SA05-100-N-40	C-SA05-100-N-40	TK290378-9	TK290378-9	Plug-in Connector with Indicator Light
DSG-005-***-A200-N1	SA05-200-N-40	C-SA05-200-N-40	TK290379-7	TK290379-7	
DSG-005-***-D12-N1	SD05-12-N-40	C-SD05-12-N-40	TK290089-2	TK290089-2	
DSG-005-***-D24-N1	SD-05-24-N-40	C-SD-05-24-N-40	TK290090-0	TK290090-0	

1/8 Solenoid Operated Directional Valves, DSG-01 Series

These are Solenoid Operated Directional Valves of high pressure, high flow and low pressure drop, the features of which can be materialized by employing a powerful wet type solenoid and the rational flow channel design.

High Pressure & High Flow Rate

In comparison to our existing lines, both the pressure and flow of these valves are much increased.

- Max. Operating Pressure: approx. 10 % increased [31.5→35 MPa (4570 →5080 PSI)]
- Max. T-Line Back Pressure: approx. 30 % increased [16→21 MPa (2320 →3050 PSI)]
- Max. Flow Rate: approx. 60 % increased [63→100 L/min (16.64 →26.42 U.S.GPM)]

Low Pressure Drop

The pressure drop of these valves is reduced by 10 % from 1.0 to 0.9 MPa (145 to 131 PSI), in comparison to our existing lines*; the valves effectively reduce the energy consumption of the unit.

{* At Flow Rate: 60 L/min (15.9 U.S.GPM), Spool Type: 3C2 (P→A)}

Compact & Small Mass

Despite of high pressure, high flow and low pressure drop, these valve bodies are compact and lightweight with DC double solenoids; the overall length and mass are reduced from 210 to 205 mm (8.26 to 8.07 inch) and from 2.2 to 1.85 kg (4.85 to 4.08 lbs), respectively.

Shockless type available

In addition to the standard valves for high pressure and high flow, a shockless type capable of minimizing noise and vibration in piping during spool changeover is also available.

Stable Operation

Due to the powerful magnetic and spring force of the solenoids, these valves exhibit a high tolerance to contaminants and especially stable operation.

IP65-equivalent high dust- and water-proof

These valves demonstrate excellent dust- and water-proof characteristics, in compliance with I. E. C. Pub. 529. IP65 and JIS C 0920 IP65 (dust- and jet-proof type).

Usable in products of various standards

These standard valves are CE certified for installation in equipment overseas. UL/CSA certified products are also available.

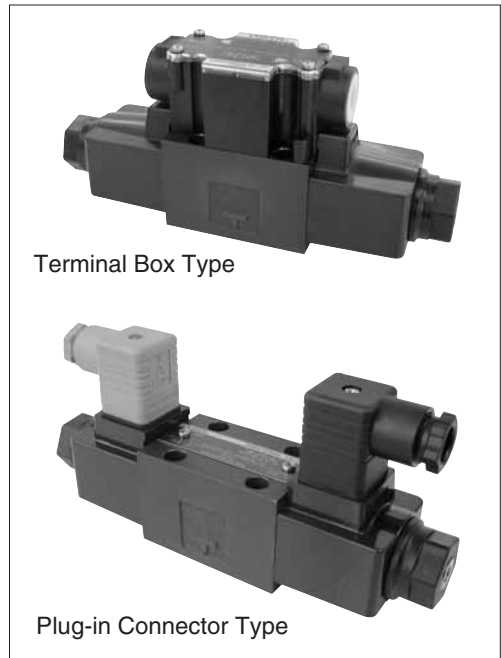

Terminal Box Type

Plug-in Connector Type

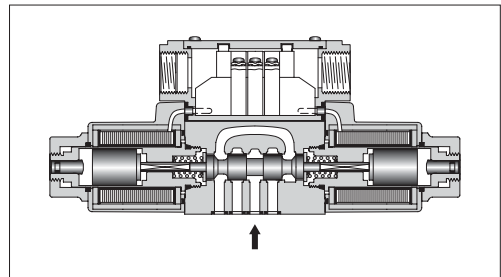

Specifications

Valve Type	Model Numbers	Max. Flow ^{★2} L/min (U.S.GPM)	Max. Operating Pressure MPa (PSI)	Max. T-Line Back Pressure MPa (PSI)	Max. Changeover Frequency Cycle/min {min ⁻¹ }	Mass kg (lbs.)
Standard Type	DSG-01-3C*-70/7090	100 (26.4)	35 (5080)	21 (3050)	300 (R Type Sol. Only) 120	1.85 (4.08)
	DSG-01-2D2*-70/7090					1.4(3.09)
	DSG-01-2B*-70/7090					1.4(3.09)
Shockless Type	S-DSG-01-3C*-70/7090	63 (16.6)	25 (3630)	21 (3050)	120	1.85(4.08)
	S-DSG-01-2B2*-70/7090					1.4(3.09)
Low Wattage(14W) Type ^{★1}	L-DSG-01-3C*-70/7090	40 (10.6)	16 (2320)	16 (2320)	300 (R Type Sol. Only) 120	1.85 (4.08)
	L-DSG-01-2D2*-70/7090					1.4(3.09)
	L-DSG-01-2N*-70/7090					
	L-DSG-01-2B***-70/7090					

★ 1. For details of L-DSG-01, please contact us.

★ 2. Maximum flow indicates a ceiling flow depends on the type of spool and operating condition, refer to the List of Spool Functions on pages 347 to 351 for details.

Sub-plate

Piping Size	Japanese Standard "JIS "		European Design Standard		N.American Design Standard		Approx. Mass kg (lbs.)
	Sub-plate Model Numbers	Thread Size	Sub-plate Model Numbers	Thread Size	Sub-plate Model Numbers	Thread Size	
1/8	DSGM-01-31	Rc 1/8	DSGM-01-3180	1/8 BSP.F	DSGM-01-3190	1/8 NPT	0.8 (1.8)
1/4	DSGM-01X-31	Rc 1/4	DSGM-01X-3180	1/4 BSP.F	DSGM-01X-3190	1/4 NPT	0.8 (1.8)
3/8	DSGM-01Y-31	Rc 3/8	—	—	DSGM-01Y-3190	3/8 NPT	0.8 (1.8)

- Sub-plates are available. Specify the sub-plate model number from the table above. When sub-plates are not used, the mounting surface should have a good machined finish.

Mounting Bolt

For socket head cap screws in the table below are included.

Descriptions	Soc. Hd. Cap Screw (4 pcs.)	Tightening Torque
Japanese Standard "JIS" European Design Standard	M5 × 45 Lg.	5 - 7 Nm (43 - 60 in. lbs.) Applicable to working pressure more than 25 MPa (3630 PSI): 6 - 7 Nm (52 - 60 in. lbs.)
N. American Design Standard	No. 10-24 UNC × 1-3/4 Lg.	

Solenoid Ratings

Valve Type	Electric source	Coil Type	Frequency (Hz)	Voltage (V)		Current & Power at Rated Voltage				
				Source Rating	Serviceable Range	Inrush (A) ^{*2}	Holding (A)	Power (W)		
Standard Type	AC ^{*1}	A100	50	100	80 - 110	2.42	0.51	—		
				100	90 - 120	2.14	0.37			
			60	110	—	2.35	0.44			
				120	96 - 132	2.02	0.42			
			60		108 - 144	1.78	0.31			
				A200	50	200	160 - 220		1.21	0.25
		200	180 - 240			1.07	0.19			
		60	220		—	1.18	0.22			
			240		192 - 264	1.01	0.21			
		60			216 - 288	0.89	0.15			
			Shockless Type		DC (K Series)	—	D12		10.8 - 13.2	—
		D24		21.6 - 26.4			—		1.23	
D48	43.2 - 52.8	—		0.61						
AC → DC Rectified (R)	50/60	R100		90 - 110	—	0.33	29			
		R200		180 - 220	—	0.16				
				—	—	—		—		

- ★1. AC solenoid is not available in shockless type. R type models with built-in current rectifier is recommended for shockless operation with AC power.
- ★2. Inrush current in the above table show rms values at maximum stroke.
- ★3. There are more coil types other than the above. For details, please make inquiries.

The coil type numbers in the shaded column are handled as optional extras. In case these coils are required to be chosen, please confirm the time of delivery with us before ordering.

Options

Push Button with Lock Nut

Can be used for manual changeover of spool. The push button can be locked in the pressed condition.

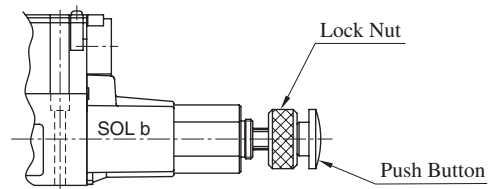

Plug-in Connector with Solenoid Indicator Light

These are the indicator light incorporated plug-in connector type solenoids. Energisation or de-energisation of the solenoid can be easily identified with the incorporated indicator light.

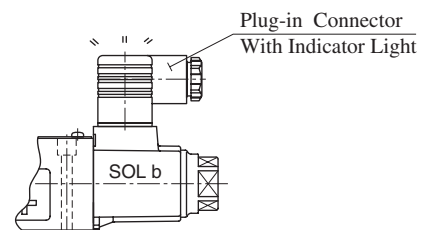

Model Number Designation









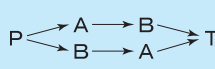
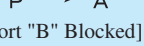

F-	S-	DSG	-01	-2	B	2	A	-D24	-C	-N	-70	*	-L			
Special Seals	Shockless Type	Series Number	Valve Size	Number of Valve Positions	Spool-Spring Arrangement	Spool Type	Special Two Position Valve (Omit if not required)	Coil Type	Manual Override	Electrical Conduit Connection	Design Number	Design Standard	Models with Reverse Mtg. of Solenoid (Omit if not required)			
F: For Phosphate Ester Type Fluids (Omit if not required)	None: Standard Type	DSG: Solenoid Operated Directional Valve	01	3: Three Positions	C: Spring Centred	2, 3 4, 40 60, 9 10, 11 12	—	AC: A100 A120 A200 A240	None: Manual Override Pin	None: Terminal Box Type	70	None: Japanese Std. "JIS" 90: N.American Design Std.	—			
						2								DC: D12 D24 D48		
	2: Two Positions			D: No-Spring Detented	2	—	R: (AC→DC) R100 R200	C: Push Button and Lock Nut (Option)						N: Plug-in Connector Type N1: ^{*2} Plug-in Connector Type with Indicator Light (Option)	None: Japanese Std. "JIS" and European Design Std.	L
S: Shockless Type				3: Three Positions	C: Spring Centred	2 4	—	DC: D12 D24 D48				90: N. American Design Std.	—			
				2: Two Positions	B: Spring Offset	2		R: (AC→DC) R100 R200						L		

★1. In case of the special two position valve, please refer to page 352 for details.
 ★2. N1 is not available for R type solenoids.

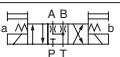
In the table above, the symbols or numbers highlighted with shade represent the optional extras. The valves with model number having such optional extras are handles as options, therefore, please confirm the time of delivery with us before ordering.

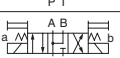
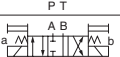
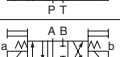
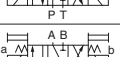
■ List of Standard Models and The Maximum Flow

● Models with AC Solenoids: DSG-01-***-A*

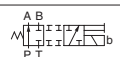
No. of Valve Positions	Spool-Spring Arrangement	Model Numbers	Graphic Symbols	Max. Flow L/min														
																		
				Working Pressure MPa					Working Pressure MPa					Working Pressure MPa				
				10	16	25	31.5	35	10	16	25	31.5	35	10	16	25	31.5	35
Three Positions	Spring Centred	DSG-01-3C2		100	100	100	100	100	100(43) 57(38)	100(41) 53(31)	80(21) 29(17)	60(17) 19(10)	38(15) 13(9)	100(43) 57(38)	100(41) 53(31)	80(21) 29(17)	60(17) 19(10)	38(15) 13(9)
		DSG-01-3C3		100(80) 90(63)	100(80) 90(63)	100(80) 90(63)	100(77) 90(63)	100(77) 90(63)	70(46) 45(30)	70(46) 45(30)	70(46) 45(30)	70(46) 45(30)	70(46) 45(30)	70(46) 45(30)	70(46) 45(30)	70(46) 45(30)	70(46) 45(30)	70(46) 45(30)
		DSG-01-3C4		90	90	90	90(22) 43(14)	35(18) 30(11)	100(38) 50(31)	76(28) 38(20)	67(15) 20(10)	57(10) 16(7)	35(7) 12(5)	100(38) 50(31)	76(28) 38(20)	67(15) 20(10)	57(10) 16(7)	35(7) 12(5)
		DSG-01-3C40		85	85	85	80(40) 63(15)	80(22) 25(10)	85(40) 70(26)	85(35) 50(24)	85(24) 32(16)	60(16) 22(13)	55(12) 18(10)	85(40) 70(26)	85(35) 50(24)	85(24) 32(16)	60(16) 22(13)	55(12) 18(10)
		DSG-01-3C60★		43(23) 40(23)	43(23) 40(23)	42(23) 38(23)	42(23) 36(23)	42(23) 35(23)	54(32) 48(30)	54(32) 47(30)	52(32) 47(30)	52(32) 47(30)	52(32) 47(30)	54(32) 48(30)	54(32) 47(30)	52(32) 47(30)	52(32) 47(30)	52(32) 47(30)
		DSG-01-3C9		100	100	100	100	100	20	15	10	10	8	20	15	10	10	8
		DSG-01-3C10◆		100	100	100(63) 80(20)	100(33) 70(20)	100(27) 40(19)	100(50) 100(37)	100(37) 55(25)	100(20) 29(14)	78(16) 20(11)	62(13) 15(10)	100(50) 100(37)	100(37) 55(25)	100(20) 29(14)	78(16) 20(11)	62(13) 15(10)
		DSG-01-3C11◆		100	100	100	100	100	23	20	13	10	5	100(65) 70(50)	85(52) 57(40)	72(45) 50(25)	65(34) 43(19)	60(27) 35(18)
		DSG-01-3C12◆		100	100	100(63) 80(20)	100(33) 70(20)	100(27) 40(19)	100(50) 100(37)	100(37) 55(25)	100(20) 29(14)	78(16) 20(11)	62(13) 15(10)	100(50) 100(37)	100(37) 55(25)	100(20) 29(14)	78(16) 20(11)	62(13) 15(10)
Two Positions	No-Spring Detented	DSG-01-2D2		80	80	80	80	80	45	45	45(21) 36(18)	45(16) 28(13)	38(13) 22(12)	50	50(45) 50(45)	50(42) 50(42)	45(40) 45(40)	45(40) 45(40)
		DSG-01-2B2		85	85	85	85	85	20	16	16	15	13	85(63) 85(30)	80(50) 60(33)	63(40) 50(28)	44(32) 40(28)	44(32) 40(28)
	Spring Offset	DSG-01-2B3		70	70	70	70	70	50	50	50	50	50	80(70) 70(48)	80(70) 70(48)	80(70) 70(48)	80(70) 70(48)	80(70) 70(48)
		DSG-01-2B8		—	—	—	—	—	26	17	13	11	10	80(50) 35(20)	70(40) 23(15)	60(20) 15(8)	45(10) 10(5)	30(10) 7(5)

Notes: 1. The relation between the maximum flow in the table above and the frequency/voltage (within the serviceable voltage) is as shown below.

(Example)

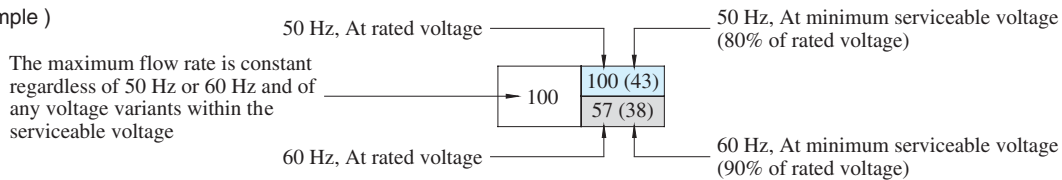











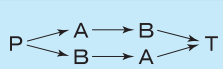
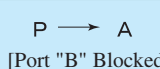
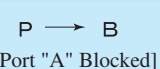
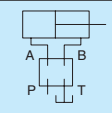
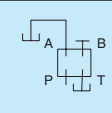
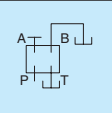

2. For the maximum flow rate in P → T of the valves with a ★ mark, please see page 351.

The valve models with a ◆ mark are handled as Options. If you choose such valves, check the time of delivery beforehand.

DSG-01 Series Solenoid Operated Directional Valves

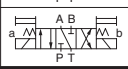
■ List of Standard Models and The Maximum Flow

● Models with DC or R Type Solenoids: DSG-01-***-D*/R*

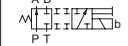
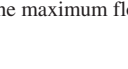
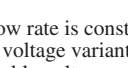
No. of Valve Positions	Spool-Spring Arrangement	Model Numbers	Graphic Symbols	Max. Flow L/mi														
									 [Port "B" Blocked]					 [Port "A" Blocked]				
																		
				Working Pressure MPa					Working Pressure MPa					Working Pressure MPa				
				10	16	25	31.5	35	10	16	25	31.5	35	10	16	25	31.5	35
Three Positions	Spring Centred	DSG-01-3C2		100	100	100	100	100	100	45	28	25	22	100	45	28	25	22
		DSG-01-3C3		100	100	100	100	100	78	78	78	78	75	78	78	78	78	75
		DSG-01-3C4		90	90	90	50	38	100	58	38	31	29	100	58	38	31	29
		DSG-01-3C40		85	85	65	40	33	85	52	30	26	24	85	52	30	26	24
		DSG-01-3C60		50	50	50	50	50	66	66	66	66	66	66	66	66	66	66
		DSG-01-3C9		100	100	100	100	100	20	15	10	10	8	20	15	10	10	8
		DSG-01-3C10		85	85	85	80	40	100	56	36	28	24	100	56	36	28	24
		DSG-01-3C11		100	100	100	100	100	23	20	13	10	5	100	60	40	36	32
		DSG-01-3C12		85	85	85	80	40	100	56	36	28	24	100	56	36	28	24
Two Positions	No-Spring Detented	DSG-01-2D2		75	75	75	75	75	45	45	40	30	27	50	50	45	45	
		DSG-01-2B2		80	80	80	80	80	20	16	16	15	13	46	31	24	22	22
	Spring Offset	DSG-01-2B3		70	70	70	70	70	50	50	50	50	50	75	75	75	75	75
		DSG-01-2B8		—	—	—	—	—	26	17	13	11	10	53	35	23	19	17
		DSG-01-2B2		80	80	80	80	80	20	16	16	15	13	32	23	19	18	18
		DSG-01-2B3		70	70	70	70	70	50	50	50	50	50	65	65	65	65	65

Notes: 1. The relation between the maximum flow in the table above and the voltage (within the serviceable voltage) is as shown below.

(Example)

The maximum flow rate is constant regardless of any voltage variants within the serviceable voltage

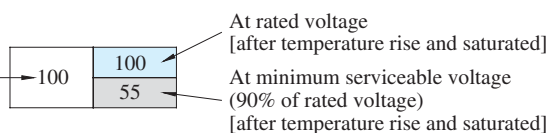









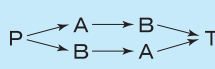
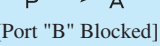

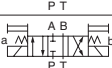
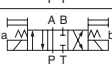

2. For the maximum flow rate in P → T of the valves with a ★ mark, please see page 351.

The valve models with a ◆ mark are handled as Options. If you choose suce valves, check the time of delivery beforehand.

■ List of Standard Models and The Maximum Flow

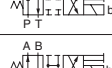
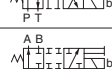
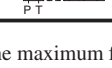
● Models with AC Solenoids: DSG-01-***-A*

No. of Valve Positions	Spool-Spring Arrangement	Model Numbers	Graphic Symbols	Max. Flow U.S.GPM														
																		
				Working Pressure PSI					Working Pressure PSI					Working Pressure PSI				
				1450	2320	3630	4570	5080	1450	2320	3630	4570	5080	1450	2320	3630	4570	5080
Three Positions	Spring Centred	DSG-01-3C2		26.4	26.4	26.4	26.4	26.4	26.4(11.4)	26.4(10.8)	21.1(5.6)	15.9(4.5)	10.0(4.0)	26.4(11.4)	26.4(10.8)	21.1(5.6)	15.9(4.5)	10.0(4.0)
		DSG-01-3C3		26.4(21.1)	26.4(21.1)	26.4(21.1)	26.4(21.1)	26.4(21.1)	18.5(12.2)	18.5(12.2)	18.5(12.2)	18.5(12.2)	18.5(12.2)	18.5(12.2)	18.5(12.2)	18.5(12.2)	18.5(12.2)	18.5(12.2)
		DSG-01-3C4		23.8	23.8	23.8	23.8(5.8)	9.2(4.8)	23.8(6.9)	11.4(3.7)	7.9(2.9)	13.2(8.2)	10.0(5.3)	5.3(2.6)	4.2(1.9)	3.2(1.3)	13.2(8.2)	10.0(5.3)
		DSG-01-3C40		22.5	22.5	22.5	21.1(10.6)	21.1(5.8)	22.5(10.6)	22.5(9.3)	22.5(6.3)	15.9(4.2)	14.5(3.2)	22.5(10.6)	22.5(9.3)	22.5(6.3)	15.9(4.2)	14.5(3.2)
		DSG-01-3C60		11.4(6.1)	11.4(6.1)	11.1(6.1)	11.1(6.1)	11.1(6.1)	14.2(8.4)	14.2(8.4)	13.7(8.4)	13.7(8.4)	13.7(8.4)	14.2(8.4)	14.2(8.4)	13.7(8.4)	13.7(8.4)	13.7(8.4)
		DSG-01-3C9		26.4	26.4	26.4	26.4	26.4	5.3	4.0	2.6	2.6	2.1	5.3	4.0	2.6	2.6	2.1
		DSG-01-3C10		26.4	26.4	26.4(16.6)	26.4(8.7)	26.4(7.1)	26.4(13.2)	26.4(9.8)	26.4(5.3)	20.6(4.2)	16.4(3.4)	26.4(13.2)	26.4(9.8)	26.4(5.3)	20.6(4.2)	16.4(3.4)
		DSG-01-3C11		26.4	26.4	26.4	26.4	26.4	6.1	5.3	3.4	2.6	1.3	26.4(17.2)	22.5(13.7)	19.0(13.7)	17.2(9.0)	15.9(7.1)
		DSG-01-3C12		26.4	26.4	26.4(16.6)	26.4(8.7)	26.4(7.1)	26.4(13.2)	26.4(9.8)	26.4(5.3)	20.6(4.2)	16.4(3.4)	26.4(13.2)	26.4(9.8)	26.4(5.3)	20.6(4.2)	16.4(3.4)
		Two Positions	No-Spring Detented	DSG-01-2D2		21.1	21.1	21.1	21.1	21.1	11.9	11.9	11.9(5.6)	11.9(4.2)	10.0(3.4)	13.2	13.2(11.9)	13.2(11.1)
DSG-01-2B2				22.5	22.5	22.5	22.5	22.5	5.3	4.2	4.2	4.0	3.4	22.5(16.6)	21.1(13.2)	16.6(10.6)	11.6(8.5)	11.6(8.5)
Spring Offset	DSG-01-2B3			18.5	18.5	18.5	18.5	18.5	13.2	13.2	13.2	13.2	13.2	21.1(18.5)	21.1(18.5)	21.1(18.5)	21.1(18.5)	21.1(18.5)
	DSG-01-2B8			—	—	—	—	—	6.9	4.5	3.4	2.9	2.6	21.1(13.2)	18.5(10.6)	15.9(5.3)	11.9(2.6)	7.9(2.6)
	DSG-01-2B2			22.5	22.5	22.5	22.5	22.5	5.3	4.2	4.2	4.0	3.4	22.5(16.6)	21.1(13.2)	16.6(10.6)	11.6(8.5)	11.6(8.5)
	DSG-01-2B3			18.5	18.5	18.5	18.5	18.5	13.2	13.2	13.2	13.2	13.2	21.1(18.5)	21.1(18.5)	21.1(18.5)	21.1(18.5)	21.1(18.5)

Notes: 1. The relation between the maximum flow in the table above and the frequency/voltage (within the serviceable voltage) is as shown below.

(Example)

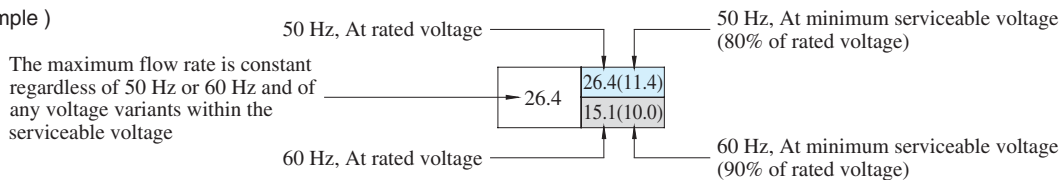

2. For the maximum flow rate in P → T of the valves with a ★ mark, please see [page 351](#).

The valve models with a ◆ mark are handled as Options. If you choose such valves, check the time of delivery beforehand.

DSG-01 Series Solenoid Operated Directional Valves

■ List of Standard Models and The Maximum Flow

● Models with DC or R Type Solenoids: DSG-01-***-D*/R*

No. of Valve Positions	Spool-Spring Arrangement	Model Numbers	Graphic Symbols	Max. Flow U.S.GPM														
				Working Pressure PSI					Working Pressure PSI					Working Pressure PSI				
				1450	2320	3630	4570	5080	1450	2320	3630	4570	5080	1450	2320	3630	4570	5080
				1450	2320	3630	4570	5080	1450	2320	3630	4570	5080	1450	2320	3630	4570	5080
Three Positions	Spring Centred	DSG-01-3C2		26.4	26.4	26.4	26.4	26.4	26.4	11.9	7.4	6.6	5.8	26.4	11.9	7.4	6.6	5.8
		DSG-01-3C3		26.4	26.4	26.4	26.4	26.4	20.6	20.6	20.6	20.6	19.8	20.6	20.6	20.6	20.6	19.8
		DSG-01-3C4		23.8	23.8	23.8	13.2	10.0	26.4	15.3	10.0	8.2	7.7	26.4	15.3	10.0	8.2	7.7
		DSG-01-3C40		22.5	22.5	17.2	10.6	8.7	22.5	13.7	7.9	6.9	6.3	22.5	13.7	7.9	6.9	6.3
		DSG-01-3C60		13.3	13.3	13.3	13.3	13.3	17.4	17.4	17.4	17.4	17.4	17.4	17.4	17.4	17.4	17.4
		DSG-01-3C9		26.4	26.4	26.4	26.4	26.4	5.3	4.0	2.6	2.6	2.1	5.3	4.0	2.6	2.6	2.1
		DSG-01-3C10		22.5	22.5	22.5	21.1	10.6	26.4	14.8	9.5	7.4	6.3	26.4	14.8	9.5	7.4	6.3
		DSG-01-3C11		26.4	26.4	26.4	26.4	26.4	6.1	5.3	3.4	2.6	1.3	26.4	15.9	10.6	9.5	8.5
		DSG-01-3C12		22.5	22.5	22.5	21.1	10.6	26.4	14.8	9.5	7.4	6.3	26.4	14.8	9.5	7.4	6.3
Two Positions	No-Spring Detented	DSG-01-2D2		19.8	19.8	19.8	19.8	19.8			10.6	7.9	7.1		13.2	13.2	11.9	11.9
				18.5	18.5	18.5	18.5	18.5	11.9	11.9	7.9	6.6	5.8	13.2	13.2	11.1	10.6	10.6
	Spring Offset	DSG-01-2B2		21.1	21.1	21.1	21.1	21.1	5.3	4.2	4.2	4.0	3.4	12.2	8.2	6.3	5.8	5.8
				18.5	18.5	18.5	18.5	18.5	13.2	13.2	13.2	13.2	13.2	8.5	6.1	5.0	4.8	4.8
				—	—	—	—	—	6.9	4.5	3.4	2.9	2.6	19.8	19.8	19.8	19.8	19.8
				—	—	—	—	—	—	—	—	—	—	17.2	17.2	17.2	17.2	17.2
Spring Offset	DSG-01-2B8		—	—	—	—	—	6.9	4.5	3.4	2.9	2.6	14.0	9.2	6.1	5.0	4.5	
			—	—	—	—	—	—	—	—	—	—	9.3	7.9	4.5	3.4	3.2	

Notes: 1. The relation between the maximum flow in the table above and the voltage (within the serviceable voltage) is as shown below.

(Example)

The maximum flow rate is constant regardless of any voltage variants within the serviceable voltage

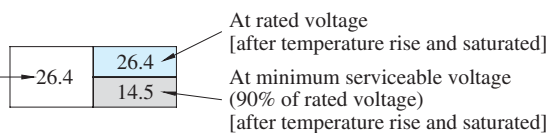

2. For the maximum flow rate in P → T of the valves with a ★ mark, please see page 351.

The valve models with a ◆ mark are handled as Options. If you choose suce valves, check the time of delivery beforehand.

Maximum Flow of Centre By-Pass

In valve type 3C60, in case where the actuator is put on in between the cylinder ports A and B as illustrated below and where the actuator moves and suspended at its stroke end and where the valve is then shifted to the neutral position in the suspended state of the actuator, the maximum flow rates available are those as shown as the table below regardless of any voltage in the range of serviceable voltage.

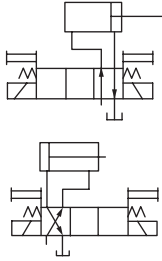

Mode Numbers	Graphic Symbol	Max. Flow L/min (U.S.GPM)				
		10 MPa (1450 PSI)	16 MPa (2320 PSI)	25 MPa (3630 PSI)	31.5 MPa (4570 PSI)	35 MPa (5080 PSI)
DSG-01-3C60-A*/D*/R*		55 (14.5)	44 (11.6)	30 (7.9)	26 (6.9)	22 (5.8)

List of Shockless Models and The Maximum Flow

- Models with DC or R Type Solenoids: S-DSG-01-***-D*/R*

No. of Valve Positions	Spool-Spring Arrangement	Model Numbers	Graphic Symbol	Max. Flow L/min (U.S.GPM)								
				Working Pressure MPa (PSI)			Working Pressure MPa (PSI)			Working Pressure MPa (PSI)		
				10 (1450)	16 (2320)	25 (3630)	10 (1450)	16 (2320)	25 (3630)	10 (1450)	16 (2320)	25 (3630)
Three Positions	Spring Centred	S-DSG-01-3C2		63 (16.6)	63 (16.6)	40 (10.6)	40 (10.6)	32 (8.5)	25 (6.6)	40 (10.6)	32 (8.5)	25 (6.6)
		S-DSG-01-3C4		60 (15.9)	50 (13.2)	40 (10.6)	40 (10.6)	32 (8.5)	16 (4.2)	40 (10.6)	32 (8.5)	16 (4.2)
Two Positions	Spring Offset	S-DSG-01-3B2		50 (13.2)	45 (11.9)	45 (11.9)	30 (7.9)	30 (7.9)	30 (7.9)	60 (15.9)	40 (10.6)	40 (10.6)
				45 (11.9)	40 (10.6)	40 (10.6)						

Notes: 1. The relation between the maximum flow in the table above and the voltage (within the serviceable voltage) is as shown below.

(Example)

The maximum flow rate is constant regardless of any voltage variants within the serviceable voltage

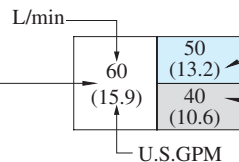

At rated voltage [after temperature rise and saturated]
 At minimum serviceable voltage (90% of rated voltage) [after temperature rise and saturated]

■ Reverse Mounting of Solenoid.

In spring offset type, it is a standard configuration that the solenoid is mounted onto the valve in the SOL b position (side). However, in this particular spool-spring arrangement, the mounting of the solenoid onto the valve in the reverse position -SOL a side- is also available. The graphic symbol for this reverse mounting is as shown below. As for the valve type 2B*A and 2B*B, please refer to the explanation under the heading of "Valves Using Neutral Position and Side Position" given below.



■ Valves Using Neutral Position and Side Position. (Special Two position Valve)

Besides the use of the standard 2-position valves aforementioned in the "List of Standard Models and Maximum Flow", the 3-position valves also can be used as the 2-position valves using the two of their three positions. In this case, there are two kinds of the valve available. One is the valve using the neutral position and SOL a position (2B*A) and another is the valve using the neutral position and SOL b position (2B*B).

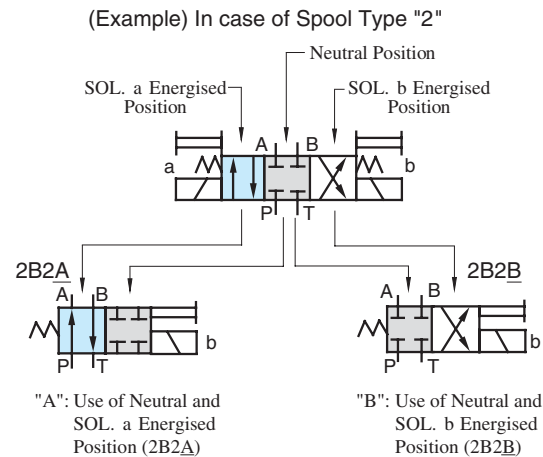

Model Numbers	Graphic SymbolsG	
	Standard Mtg. Type	Reverse Mtg. Type
DSG-01-2B*A		
DSG-01-2B2A		—

Model Numbers	raphic Symbols	
	Standard Mtg. Type	Reverse Mtg. Type
DSG-01-2B*B		
DSG-01-2B2B		—
DSG-01-2B3B		—
DSG-01-2B4B		
DSG-01-2B60B		—
DSG-01-2B10B		—

In the above table, the graphic symbols in mounting type highlighted with shade are optional extra, therefore, please confirm the time of delivery with us before ordering.

■ Typical Changeover Time

Changeover time varies according to oil viscosity, spool type and hydraulic circuit.

● Standard Type (Without Shockless Function)

[Test Conditions]

Pressure: 16 MPa (2320 PSI)
 Flow Rate: 31.5 L/min (8.3 U.S.GPM)
 Viscosity: 35 mm²/s (164 SSU)
 Voltage: 100 %V
 (After coil temprature rises and saturated)

[Result of Measurement]

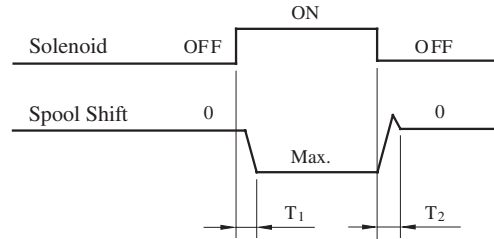

Type	Model Numbers	Time ms	
		T ₁	T ₂
Standard Type	DSG-01-3C2- A*	15	23
	DSG-01-3C2- D*	48	19
	DSG-01-3C2- R*	50	100

● Shockless Type

[Test Circuit and Conditions]

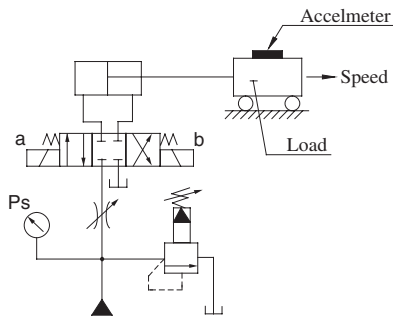

Setting Pressure (Ps): 7 MPa (1020 PSI)
 Load (W): 1000 kg (2205 lbs.)
 Speed: 8 m/min (26.2 ft./min)
 Viscosity: 35 mm²/s (164 SSU)

[Results of Measurement]

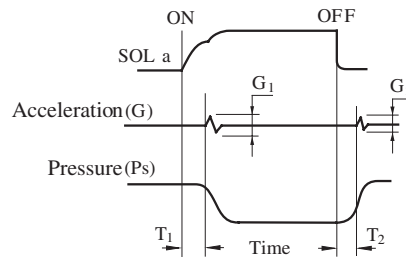

Type	Model Numbers	Time ms		Acceleration m/s ² (G)	
		T ₁	T ₂	G ₁	G ₂
Shockless Type	S-DSG-01-3C2- D*	70	30	12 (1.2)	7 (0.7)
Standard Type	DSG-01-3C2- D*	35	25	18 (1.8)	15 (1.5)

Pressure Drop

Pressure drop curves based on viscosity of 35 mm²/s (164 SSU) and specific gravity of 0.850.

Standard Type: DSG-01

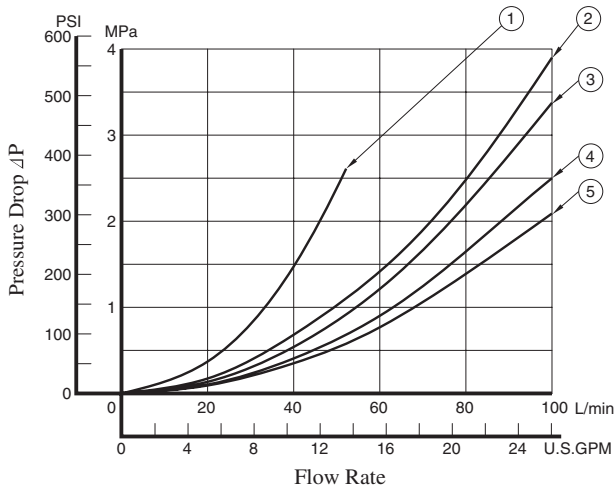

Model Numbers	Pressure Drop Curve Number				
	P→A	B→T	P→B	A→T	P→T
DSG-01-3C2	④	④	④	④	—
DSG-01-3C3	⑤	⑤	⑤	⑤	②
DSG-01-3C4	④	④	④	④	—
DSG-01-3C40	④	④	④	④	—
DSG-01-3C60	①	①	①	①	②
DSG-01-3C9	⑤	③	⑤	③	—
DSG-01-3C10	④	⑤	④	④	—
DSG-01-3C11	④	④	④	④	—
DSG-01-3C12	④	④	④	⑤	—
DSG-01-2D2	⑤	④	⑤	④	—
DSG-01-2B2	⑤	④	⑤	④	—
DSG-01-2B3	⑤	⑤	⑤	⑤	—
DSG-01-2B8	⑤	—	④	—	—

Shockless Type: S-DSG-01

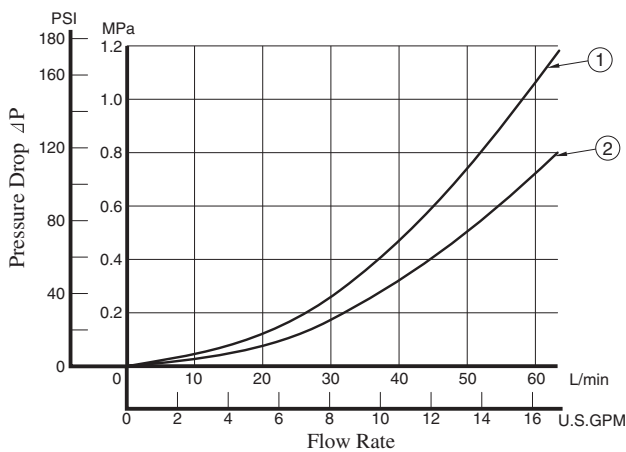

Model Numbers	Pressure Drop Curve Number			
	P→A	B→T	P→B	A→T
S-DSG-01-3C2	①	①	①	①
S-DSG-01-3C4	①	②	①	②
S-DSG-01-2B2	①	①	①	①

For any other viscosity, multiply the factors in the table below.

Viscosity	mm ² /s	15	20	30	40	50	60	70	80	90	100
		SSU	77	98	141	186	232	278	324	371	417
Factor		0.81	0.87	0.96	1.03	1.09	1.14	1.19	1.23	1.27	1.30

For any other specific gravity (G'), the pressure drop (ΔP') may be obtained from the formula below.

$$\Delta P' = \Delta P (G'/0.850)$$

Mounting surface: ISO 4401-AB-03-4-A

TERMINAL BOX TYPE

Models with AC Solenoids

- Double Solenoid: Spring Centred & No-Spring Detented

DSG-01-3C*-A*-70/7090

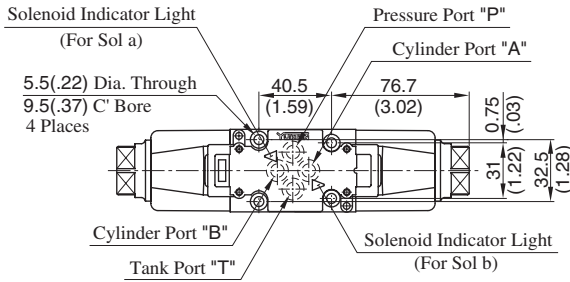

- Single Solenoid: Spring Offset
DSG-01-2B*-A*-70/7090

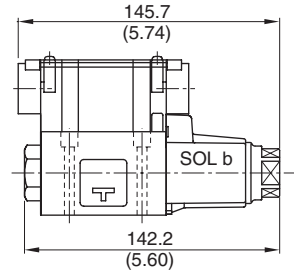

- For other dimensions, refer to "spring Centred and No-Spring Detented" models.
- Solenoid being mounted in the reverse position SOL a side is also available.

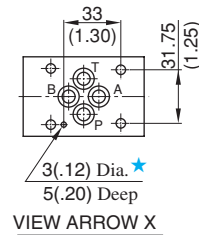
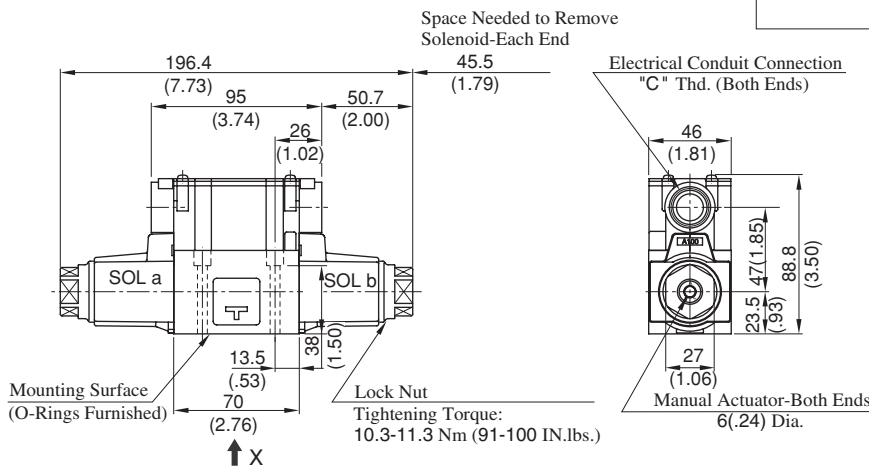

Model Numbers	"C" Thd.
DSG-01-***-A*-70	G 1/2
DSG-01-***-A*-7090	1/2 NPT

- ★ Locating pin can be fitted to this hole to conform with ISO4401-03-02-94. However, locating pin is not provided to standard design valve. When ordering valve with a locating pin, please consult Yuken.

DIMENSIONS IN MILLIMETRES (INCHES)

Models with DC Solenoids: (S-)DSG-01-***-D*-70/7090

Models with R Type Solenoids: (S-)DSG-01-***-R*-70/7090

- Spring Centred
- No-Spring Detented
- Spring Offset

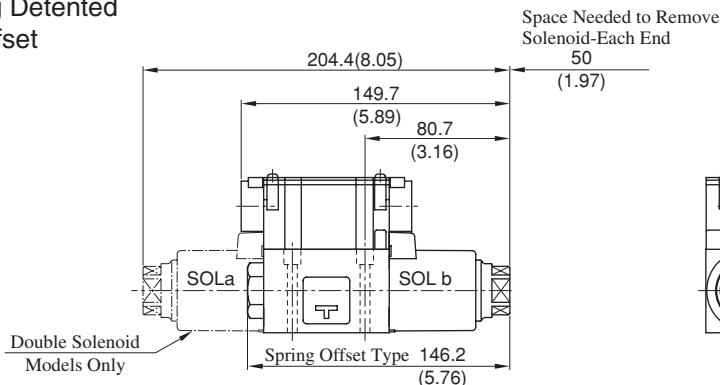

- For other dimensions, refer to models with AC solenoids.

E

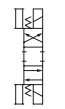

DSG-01 Series Solenoid Operated Directional Valves

■ Sub-plate : DSGM-01/01X/01Y-31/3180/3190

**DIMENSIONS IN
MILLIMETRES (INCHES)**

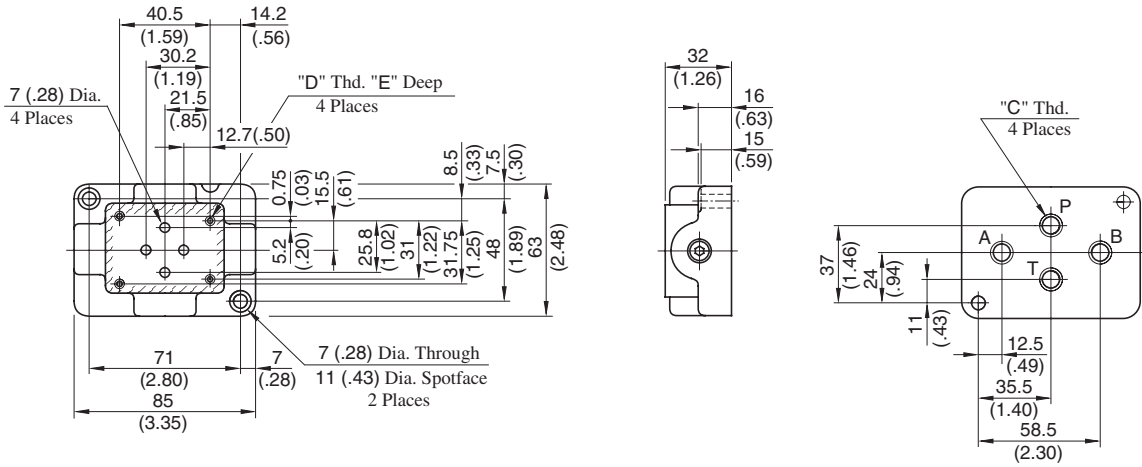

Sub-plate Model Numbers	Piping Size "C" Thd.	"D" Thd.	"E" mm(IN.)
DSGM-01-31	Rc 1/8	M5	10 (.39)
DSGM-01-3180	1/8 BSP.F		
DSGM-01-3190	1/8 NPT	No.10-24 UNC	12 (.47)
DSGM-01X-31	Rc 1/4	M5	10 (.39)
DSGM-01X-3180	1/4 BSP.F		
DSGM-01X-3190	1/4 NPT	No.10-24 UNC	12 (.47)
DSGM-01Y-31	Rc 3/8	M5	10 (.39)
DSGM-01Y-3190	3/8 NPT	No. 10-24 UNC	12 (.47)

PLUG-IN CONNECTOR TYPE (N) PLUG-IN CONNECTOR WITH INDICATOR LIGHT (N1)

- Models with AC Solenoids: DSG-01-***-A*-N₁-70/7090
- Models with DC Solenoids: (S-)DSG-01-***-D*-N₁-70/7090
- Models with R Solenoids: (S-)DSG-01-***-R*-N-70/7090

DIMENSIONS IN
MILLIMETRES (INCHES)

The position of the Plug-in connector can be changed as illustrated below by loosening the lock nut. After completion of the change, be sure to tighten the lock nut with the torque as specified below.

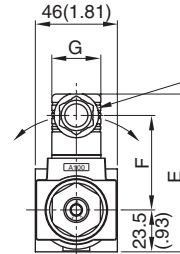
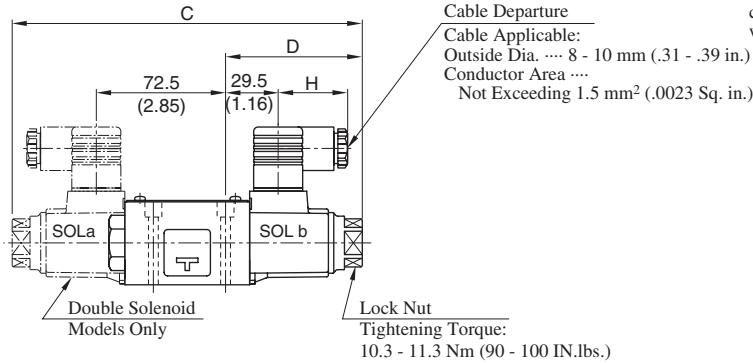

Model Numbers	C	D	E	F	G	H
DSG-01-***-A*-N*	196.4 (7.73)	76.7 (3.02)	88.5 (3.48)	53 (2.09)	27.5 (1.08)	39 (1.54)
(S-)DSG-01-***-D*-N*	204.4 (8.05)	80.7 (3.18)	99.5 (3.92)	64 (2.52)	27.5 (1.08)	39 (1.54)
(S-)DSG-01-***-R*-N	204.4 (8.05)	80.7 (3.18)	102.5 (4.04)	57.2 (2.25)	34 (1.34)	53 (2.09)

● For other dimensions, refer to "Terminal Box type" (Page 356).

Models with Push Button & Lock Nut (S-)DSG-01-***-*-C

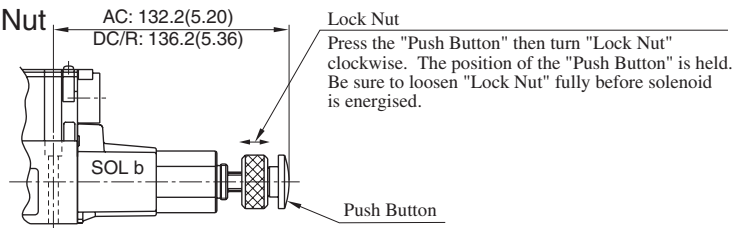

Interchangeability in Installation Current and New Design

In order to achieve higher pressure, higher flow, lower pressure drop DSG-01 valves has been upgraded from the 60 design series to the 70 design series.

The figures in the table below are the comparison between the current and the new design valves.

Specifications

Design Number	Max. Flow L/min (U.S.GPM)	Max. Operating Pressure MPa (PSI)	Max. T-Line Back Pres. MPa (PSI)	Max. Changeover Frequency Cycle/min (min ⁻¹)	Pressure Drop* MPa (PSI) {P→A}	Mass kg (lbs.)	
						3C*/2D*	2B*
New Design: 70	100(26.4)	35(5080)	21(3050)	300 (R Type sol. Only 120)	0.9(130) 1.0(145)	1.85(4.08)	1.4(3.09)
Current Design: 60	63(16.6)	31.5(4570)	16(2320)			2.2(4.85)	1.6(3.53)

* Flow Rate: 60 L/min (15.9 U.S.GPM), Viscosity: 30 mm²/s (141 SSU), Spool type "2" (Closed centre)

Interchangeability in Installation

Interchangeability in installation is maintained though there are minor differences in dimension as in the following table.

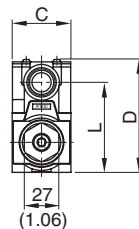
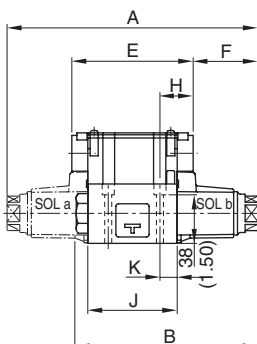

Coil Type	Design Number	A	B	C	D	E	F	H	J	K	L
AC	New Design : 70	196.4 (7.73)	142.2 (5.60)	46 (1.81)	88.8 (3.50)	95 (3.74)	50.7 (2.00)	26 (1.02)	70 (2.76)	13.5 (.53)	70.5 (2.78)
	Current Design : 60	191.4 (7.54)	142.7 (5.62)	48 (1.89)	90.3 (3.56)	90 (3.54)	50.7 (2.00)	23.5 (.93)	65 (2.56)	11 (.43)	72 (2.83)
DC R	New Design : 70	204.4 (8.05)	146.2 (5.76)	46 (1.81)	88.8 (3.50)	95 (3.74)	54.7 (2.15)	26 (1.02)	70 (2.76)	13.5 (.53)	70.5 (2.78)
	Current Design : 60	210 (8.27)	152 (5.98)	48 (1.89)	90.3 (3.56)	90 (3.54)	60 (2.36)	23.5 (.93)	65 (2.56)	11 (.43)	72 (2.83)

Details of Receptacle

Type of Electrical Conduit Connection	Double Solenoid Type	Single Solenoid Type
Terminal Box Type		
Plug-in Connector Type		

- ★1. There are two grounding terminals. You can use either one.
- ★2. If you do not need the common plate, remove it.
- ★3. With DC solenoids, polarity is no question.

⚠ DANGER

- Do not perform wiring while the power is on. Doing so may result in electric shock, burns or death.
- Make the wiring properly. Improper wiring will cause an irregular movement of the machine, resulting in a grave accident.

Electrical Circuit

Type of Electrical Conduit Connection	Electric Source		
	AC	DC	AC→DC Rectified
Terminal Box Type			
Plug-in Connector Type			

List of Seals

*-DSG-01-***-*-70/7090

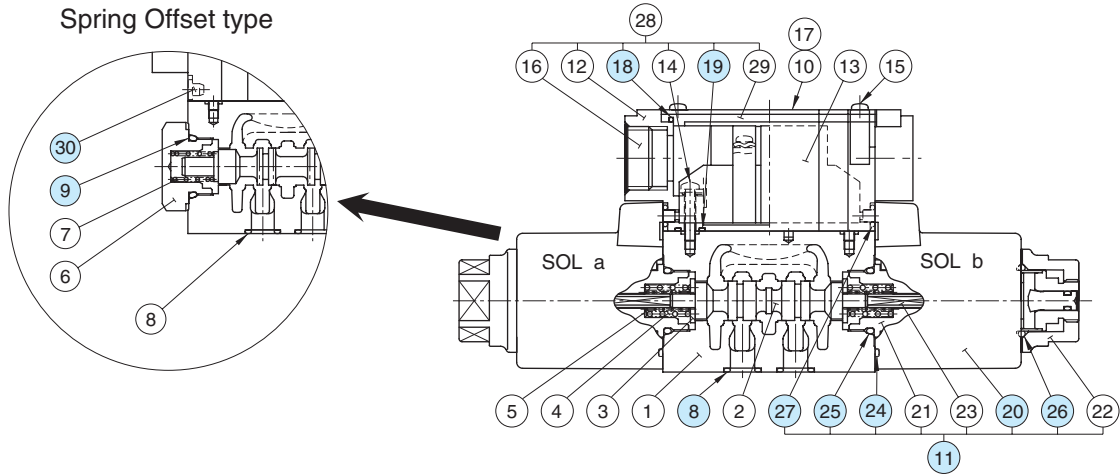

*-DSG-01-***-*-N/N1-70/7090

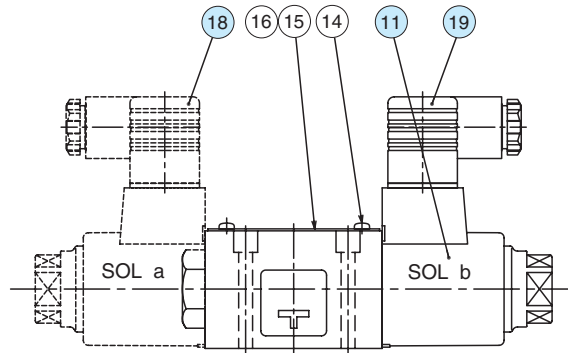

List of Seals

Item	Name of Parts	Part Numbers	Qty.			Remarks
			3C*	2D*	2B*	
8	O-Ring	SO-NB-A-012 (NBR, Hs90)	4	4	4	
9	O-Ring	SO-NB-P18	—	—	1	
18	Packing	1790S-VK421290-8	1	1	1	
19	O-Ring	S6	2	2	2	
24	O-Ring	AS 568-026 (NBR, Hs70)	2	2	1	} Included in Solenoid Ass'y (Item 11)
25	O-Ring	SO-NB-P18	2	2	1	
26	O-Ring	SO-NA-P20	2	2	1	
27	O-Ring	SO-NA-P4	4	4	2	
30	Plug	1790S-VK418329-9	—	—	2	

★ When ordering the O-Rings, please specify the seal kit number from the table below.

Valve Model Numbers	Seal Kit No.	O-Ring Details for Seal Kit
*-DSG-01-***-*-70/7090	KS-DSG-01-70	⑧(4 Pcs.), ⑨ & ⑳(2 Pcs., see above), ㉓(4 Pcs.)
*-DSG-01-***-*-N-70/7090	KS-DSG-01-N-70	⑧(4 Pcs.), ⑨ & ⑳(2 Pcs., see above)

● Solenoid Ass'y, Coil, Receptacle and Connector Refer to [page 360](#) for the details of these parts.

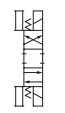

■ Solenoid Ass'y, Coil, Receptacle and Connector Ass'y No.

Valve Model Numbers	⑪ Solenoid Ass'y No.	⑫ Coil No.	⑬ Receptacle Part No.	⑱ Connector Ass'y Part No.	⑲ Connector Ass'y Part No.	Remarks		
DSG-01-***-A100-70*	SA1-100-70	C-SA1-100-70	R1-70	—	—	Terminal Box Type		
DSG-01-***-A120-70*	SA1-120-70	C-SA1-120-70						
DSG-01-***-A200-70*	SA1-200-70	C-SA1-200-70						
DSG-01-***-A240-70*	SA1-240-70	C-SA1-240-70						
DSG-01-***-D12-70*	SD1-12-70	C-SD1-12-70	KR1-A-70					
DSG-01-***-D24-70*	SD1-24-70	C-SD1-24-70	KR1-B-70					
DSG-01-***-D48-70*	SD1-48-70	C-SD1-48-70	RR1-70					
DSG-01-***-R100-70*	SR1-100-70	C-SR1-100-70	KR1-A-70					
DSG-01-***-R200-70*	SR1-200-70	C-SR1-200-70						
S-DSG-01-***-D12-70*	SD1-12-S-70	C-SD1-12-70	KR1-B-70					
S-DSG-01-***-D24-70*	SD1-24-S-70	C-SD1-24-70	RR1-70					
S-DSG-01-***-D48-70*	SD1-48-S-70	C-SD1-48-70						
S-DSG-01-***-R100-70*	SR1-100-S-70	C-SR1-100-70	RR1-70					
S-DSG-01-***-R200-70*	SR1-200-S-70	C-SR1-200-70						
DSG-01-***-A100-N-70*	SA1-100-N-70	C-SA1-100-N-70	—				GDM-211-A-11	GDM-211-B-11
DSG-01-***-A120-N-70*	SA1-120-N-70	C-SA1-120-N-70						
DSG-01-***-A200-N-70*	SA1-200-N-70	C-SA1-200-N-70						
DSG-01-***-A240-N-70*	SA1-240-N-70	C-SA1-240-N-70						
DSG-01-***-D12-N-70*	SD1-12-N-70	C-SD1-12-N-70						
DSG-01-***-D24-N-70*	SD1-24-N-70	C-SD1-24-N-70						
DSG-01-***-D48-N-70*	SD1-48-N-70	C-SD1-48-N-70		GDME-211-R-A-10	GDME-211-R-B-10			
DSG-01-***-R100-N-70*	SR1-100-N-70	C-SR1-100-N-70						
DSG-01-***-R200-N-70*	SR1-200-N-70	C-SR1-200-N-70		GDM-211-A-11	GDM-211-B-11			
S-DSG-01-***-D12-N-70*	SD1-12-S-N-70	C-SD1-12-N-70						
S-DSG-01-***-D24-N-70*	SD1-24-S-N-70	C-SD1-24-N-70		GDME-211-R-A-10	GDME-211-R-B-10			
S-DSG-01-***-D48-N-70*	SD1-48-S-N-70	C-SD1-48-N-70						
S-DSG-01-***-R100-N-70*	SR1-100-S-N-70	C-SR1-100-N-70		GDML-211-1-11	GDML-211-1-11			
S-DSG-01-***-R200-N-70*	SR1-200-S-N-70	C-SR1-200-N-70						
DSG-01-***-A100-N1-70*	SA1-100-N-70	C-SA1-100-N-70		—	GDML-211-2-11	GDML-211-2-11	Plug-in Connector with Indicator Light	
DSG-01-***-A120-N1-70*	SA1-120-N-70	C-SA1-120-N-70						
DSG-01-***-A200-N1-70*	SA1-200-N-70	C-SA1-200-N-70			GDML-211-3-11	GDML-211-3-11		
DSG-01-***-A240-N1-70*	SA1-240-N-70	C-SA1-240-N-70						
DSG-01-***-D12-N1-70*	SD1-12-N-70	C-SD1-12-N-70	GDML-211-1-11		GDML-211-1-11			
DSG-01-***-D24-N1-70*	SD1-24-N-70	C-SD1-24-N-70						
DSG-01-***-D48-N1-70*	SD1-48-N-70	C-SD1-48-N-70	GDML-211-2-11		GDML-211-2-11			
S-DSG-01-***-D12-N1-70*	SD1-12-S-N-70	C-SD1-12-N-70						
S-DSG-01-***-D24-N1-70*	SD1-24-S-N-70	C-SD1-24-N-70	GDML-211-3-11		GDML-211-3-11			
S-DSG-01-***-D48-N1-70*	SD1-48-S-N-70	C-SD1-48-N-70						

Note: The connector assembly is not included in the solenoid assembly.

3/8 Solenoid Operated Directional Valves, DSG-03 Series

These are epoch-making solenoid operated valves of high pressure, high flow which have been developed incorporating a unique design concept into every part of the valve including the solenoid. With wet type solenoids, these valves ensure the low noise and the long life, moreover, ensure no leakage of oil outside of the valves.

Wide Range of Models

Choose the optimum valve to meet your need from a large selection available. The DSG-03 50 design series solenoid operated directional valves are classified into the two basic models.

- Standard type Useable at high pressure: 31.5 MPa (4570 PSI) and high flow: 120 L/min (31.7 U.S.GPM)
- Shockless type A noise at spool changeover and a vibration in piping can be reduced to a minimum.

Stable Operation

With a strong magnet and spring force, the valves are tough against contamination and thus ensure a stable operation.

Usable in products of various standards

CE/UL/CSA certified products are available.

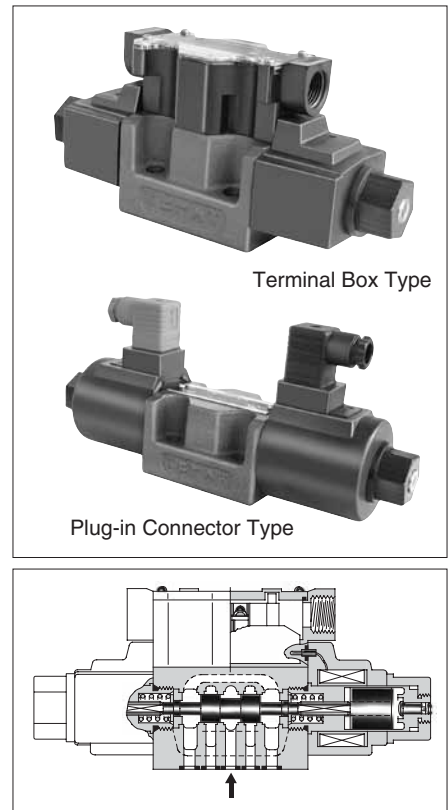

Specifications

Valve Type	Model Numbers	Max. Flow L/min (U.S.GPM)	Max. Operating Pressure MPa (PSI)	Max. T-Line Back Pres. MPa (PSI)	Max. Changeover Frequency min ⁻¹ (Cycles/Min)	Approx. Mass kg(1bs.)	
						Type of Solenoid	
						AC	DC, R, RQ
Standard Type	DSG-03-3C*-*/-50/5090	120 (31.7)	31.5 (4570) [Spool Type 60 Only] 25 (3630)]	16 (2320)	240 (R Type Sol. Only) 120	3.6 (7.9)	5 (11)
	DSG-03-2D2*-*/-50/5090					2.9 (6.4)	3.6 (7.9)
	DSG-03-2B*-*/-50/5090					—	3.6 (7.9)
Shockless Type	S-DSG-03-3C*-*/-50/5090	120 (31.7)	25 (3630)	16 (2320)	120	—	5 (11)
	S-DSG-03-2B2*-*/-50/5090					—	3.6 (7.9)
Low Wattage (14W)Type	L-DSG-03-3C*-*/-50/5090	60 (15.9)	16 (2320)	16 (2320)	240 (R Type Sol. Only) 120	3.6 (7.9)	5 (11)
	L-DSG-03-2D2*-*/-50/5090					—	3.6 (7.9)
	L-DSG-03-2B*-*/-50/5090					2.9 (6.4)	3.6 (7.9)

★1 For details of L-DSG-03, please contact us.

★2 The maximum flow means the limited flow without inducing any abnormality to the operation (changeover) of the valve. The maximum flow differs according to the spool type and operating conditions. For details, please refer to the "List of Standard Models and Maximum Flow" on pages 364 to 368.

Sub-plate

Piping Size	Japanese Standard "JIS"		European Design Standard		N.American Design Standard		Approx. Mass kg (lbs.)
	Sub-plate Model Numbers	Thread Size	Sub-plate Model Numbers	Thread Size	Sub-plate Model Numbers	Thread Size	
3/8	DSGM-03-40	Rc 3/8	DSGM-03-2180	3/8 BSP.F	DSGM-03-2190	3/8 NPT	3.0 (6.6)
1/2	DSGM-03X-40	Rc 1/2	DSGM-03X-2180	1/2 BSP.F	DSGM-03X-2190	1/2 NPT	3.0 (6.6)
3/4	DSGM-03Y-40	Rc 3/4	DSGM-03Y-2180	3/4 BSP.F	DSGM-03Y-2190	3/4 NPT	4.7 (10.4)

- Sub-plates are available. Specify the sub-plate model number from the table above. When sub-plates are not used, the mounting surface should have a good machined finish.

Mounting Bolts

For socket head cap screws in the table below are included.

Descriptions	Soc. Hd. Cap Screw (4 pcs.)	Tightening Torque
Japanese Standard "JIS" European Design Standard	M6 × 35 Lg.	12 - 15 Nm (106 - 133 in. lbs.)
N. American Design Standard	1/4-20 UNC × 1-1/2 Lg.	

E
DSG-03 Series Solenoid Operated Directional Valves

Solenoid Ratings

Valve Type	Electric source	Coil Type	Frequency (Hz)	Voltage (V)		Current & Power at Rated Voltage		
				Source Rating	Serviceable Range	Inrush (A) ^{★2}	Holding (A)	Power (W)
Standard Type	AC ^{★1}	A100	50	100	80 - 110	5.37	0.90	—
			60	100	90 - 120	4.57	0.63	
				110		5.03	0.77	
		A120	50	120	96 - 132	4.48	0.75	
			60		108 - 144	3.81	0.52	
		A200	50	200	160 - 220	2.69	0.45	
					180 - 240	2.29	0.31	
			60	220		2.52	0.38	
					A240	50	240	
		60	216 - 288	1.91		0.26		
Shockless Type	DC (K Series)	D12	—	12	10.8 - 13.2	—	3.16	38
		D24		24	21.6 - 26.4		1.57	
		D100		100	90 - 110		0.38	
	AC→DC Rectified (R)	R100	50/60	100	90 - 110	—	0.43	38
		R200		200	180 - 220		0.21	
	AC→DC Rectified (RQ) (Quick Return)	RQ100	50/60	100	90 - 110	—	0.43	38

- ★1. AC solenoid is not available in shockless type.
R or RQ type models with built-in current rectifier is recommended for shockless operation with AC power.
- ★2. Inrush current in the above table show rms values at maximum stroke.
- ★3. There are more coil types other than the above. For details, please make inquiries .

The coil type numbers in the shaded column are handled as optional extras. In case these coils are required to be chosen, please confirm the time of delivery with us before ordering .

Options

● Push Button with Lock Nut

Can be used for manual changeover of spool. The push button can be locked in the pressed condition.

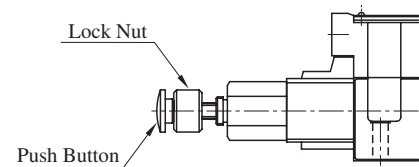

● Plug-in Connector with Solenoid Indicator Light

These are the indicator light incorporated plug-in connector type solenoids. Energisation or de-energisation of the solenoid can be easily identified with the incorporated indicator light.

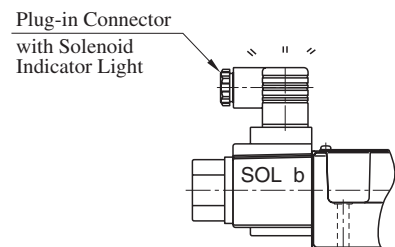

● M8 Mounting Bolts.

As the mounting bolts, M6 socket head cap screws are used for the standard valves, however, M8 socket head cap screws are also available for supply as optional extras. In case the M8 screws are required, suffix "02" to the design number of both valve and sub-plate model number like below.

(Example)

Valve: DSG-03-3C2-A100-5002
Sub-plate: DSGM-03-4002

The valve is supplied with 4 pcs. hexagon socket head cap screws M8 × 38 Lg.

Model Number Designation

F-	S-	DSG	-03	-2	B	2	A	-D24	-C	-N	-50	*	-L								
Special Seals	Shockles Type	Series Number	Valve Size	Number of Valve Positions	Spool-Spring Arrangement	Spool Type	Special Two Position Valve (Omit if not required)	Coil Type	Manual Override	Electrical Conduit Connection	Design Number	Design Standard	Models with Reverse Mtg. of Solenoid (Omit if not required)								
F: For Phosphate Ester Type Fluids (Omit if not required)	None: Standard Type	DSG: Solenoid Operated Directional Valve	03	3: Three Positions	C: Spring Centred	2, 3	—	AC: A100 A120 A200 A240	None: Manual Override Pin	None: Terminal Box Type	50	None: Japanese Std. "JIS" 90: N.American Design Std.	—								
						4,40 5 ,60 9, 10 11 , 12		DC: D12 D24 D100													
						2: Two Positions		D: No-Spring Detented						2	—	R: (AC→DC) R100 R200					
	3: Three Positions			C: Spring Centred	2 4	—	RQ: (AC→DC) RQ100	C: Push Button and Lock Nut (Option)						N: ^{*2} Plug-in Connector Type N1: ^{*3} Plug-in Connector Type with Indicator Light (Option)	None: Japanese Std. "JIS" and European Design Std. 90: N.American Design Std.	—					
																	2: Two Positions	B: Spring Offset	2 3 8	A ^{*1} B ^{*1}	RQ100
2: Two Positions	B: Spring Offset	2	A ^{*1} B ^{*1}	RQ100																	









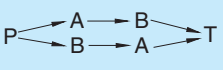
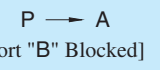
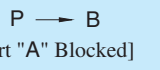
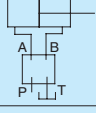
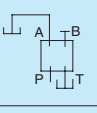
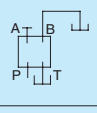

- ★ 1. In case of the special two position valve, please refer to [page 369](#) for details.
- ★ 2. N is not available for RQ-type solenoids .
- ★ 3. N1 is not available for R and RQ-type solenoids .

In the table above, the symbols or numbers highlighted with shade represent the optional extras. The valves with model number having such optional extras are handles as options, therefore, please confirm the time of delivery with us before ordering.

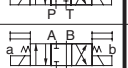

■ List of Standard Models and The Maximum Flow

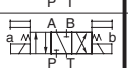
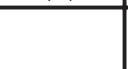
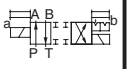
● Models with AC Solenoids: DSG-03-***-A*

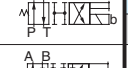
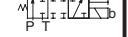
No. of Valve Positions	Spool-Spring Arrangement	Model Numbers	Graphic Symbols	Max. Flow L/min												
																
																
				Working Pressure MPa				Working Pressure MPa				Working Pressure MPa				
		10	16	25	31.5	10	16	25	31.5	10	16	25	31.5			
Three Positions	Spring Centred	DSG-03-3C2		100	100	100	100	100(70)	100(48)	96(28)	65(24)	100(70)	100(48)	96(28)	65(24)	
		DSG-03-3C3		90	90	90	90	100(81)	100(81)	100(81)	100(81)	100(81)	100(81)	100(81)	100(81)	100(81)
		DSG-03-3C4		80	80	80(65)	80(25)	100(58)	100(33)	76(22)	46(19)	100(58)	100(33)	76(22)	46(19)	
		DSG-03-3C40		100	100	100	100	100(75)	100(62)	100(39)	84(21)	48(18)	100(62)	100(39)	84(21)	48(18)
		DSG-03-3C5		30	30	30	30	26	21	18	16	30	28	28	28	
		DSG-03-3C60		70	70	70	—	100	100	100	—	100	100	100	—	
		DSG-03-3C9		100	100	100	100	60	60	60	60	60	60	60	60	
		DSG-03-3C10		80	80	80(30)	80(20)	100(55)	100(36)	60(21)	34(16)	100(55)	100(36)	60(21)	34(16)	
		DSG-03-3C11		100	100	100	100	100(80)	100(65)	85(35)	62(28)	100(80)	100(65)	85(35)	62(28)	
		DSG-03-3C12		90	90	90(30)	90(20)	100(55)	100(36)	60(21)	34(16)	100(55)	100(36)	60(21)	34(16)	
Two Positions	No-Spring Detented	DSG-03-2D2		100	100	100	100	40	40	30	28	60	60	40	35	
		Spring Offset	DSG-03-2B2		100	100	100	100	100(90)	100(90)	100(90)	100(90)	34	24	20	19
			DSG-03-2B3		100	100	100	100	100(75)	100(75)	100(75)	100(75)	57	57	57	57
			DSG-03-2B8		—	—	—	—	—	—	—	—	26	19	18	16

Notes : 1. The relation between the maximum flow in the table above and the frequency/voltage (within the serviceable voltage) is as shown below.

(Example)

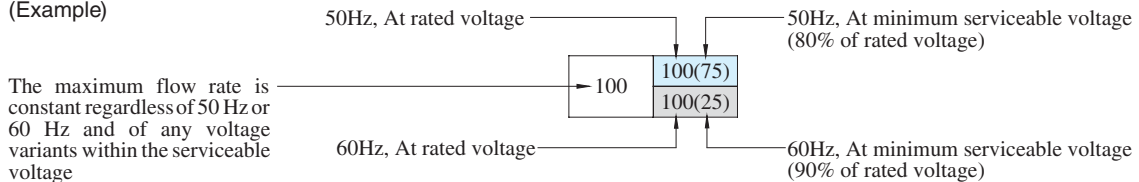

2. For the maximum flow rate in P→T of the valves with a ★ mark, please see [page 368](#).

The valve models with a ◆ mark are handled as Options. If you choose such valves, check the time of delivery beforehand.

■ List of Standard Models and The Maximum Flow

- Models with DC Solenoids: DSG-03-***-D*
- Models with R Type Solenoids: DSG-03-***-R*
- Models with RQ Type Solenoids: DSG-03-***-RQ100*

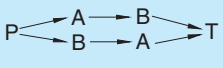
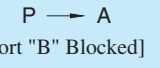
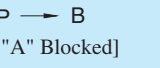
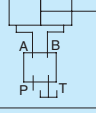
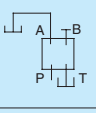
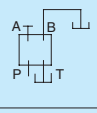
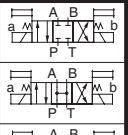
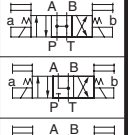
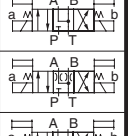
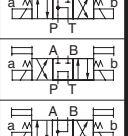
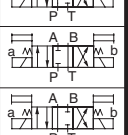
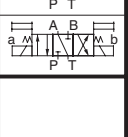
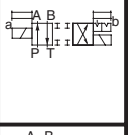
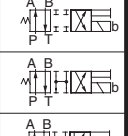
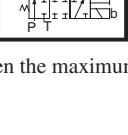
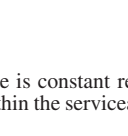
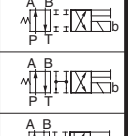
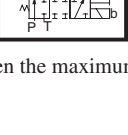
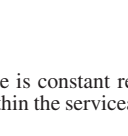
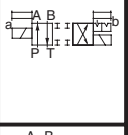
No. of Valve Positions	Spool-Spring Arrangement	Model Numbers	Graphic Symbols	Max. Flow L/min											
								 [Port "B" Blocked]				 [Port "A" Blocked]			
															
				Working Pressure MPa				Working Pressure MPa				Working Pressure MPa			
				10	16	25	31.5	10	16	25	31.5	10	16	25	31.5
Three Positions	Spring Centred	DSG-03-3C2		120	120	120	120	120	120	80	55	120	120	80	55
		DSG-03-3C3		120	120	120	120	120	120	120	120	120	120	120	120
		DSG-03-3C4		120	120	120	120	120	120	84	64	120	120	84	64
		DSG-03-3C40		120	120	120	120	120	120	65	53	120	120	65	53
		DSG-03-3C5		50	50	50	50	35	24	21	20	45	45	45	45
		DSG-03-3C60		120	120	120	—	120	120	120	—	120	120	120	—
		DSG-03-3C9		120	120	120	120	100	100	100	100	100	100	100	100
		DSG-03-3C10		120	120	120	65	120	112	60	51	120	112	60	51
		DSG-03-3C11		120	120	120	120	100	100	80	65	100	100	80	65
		DSG-03-3C12		120	120	120	65	120	120	62	51	120	120	62	51
Two Positions	Spring Offset	DSG-03-2B2		110	110	110	110	68	47	38	38	120	114	75	63
		DSG-03-2B3		120	120	120	120	77	77	77	77	120	120	120	120
		DSG-03-2B8		—	—	—	—	53	33	24	23	120	120	62	47
		DSG-03-2D2		120	120	120	120	45	37	30	28	60	60	40	35

Notes) 1. The relation between the maximum flow in the table above and the voltage (within the serviceable voltage) is as shown below.

(Example)

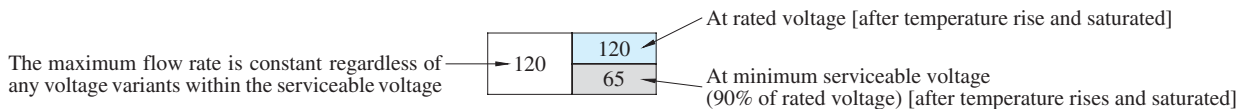









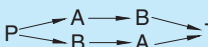
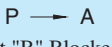
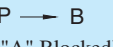

2. For the maximum flow rate in P → T of the valves with a ★ mark, please see [page 368](#).

The valve models with a ◆ mark are handled as Options. If you choose such valves, check the time of delivery beforehand.

DSG-03 Series Solenoid Operated Directional Valves

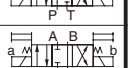
■ List of Standard Models and The Maximum Flow

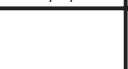
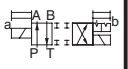
● Models with AC Solenoids: DSG-03-***-A*

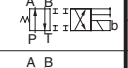
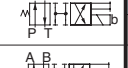
No. of Valve Positions	Spool-Spring Arrangement	Model Numbers	Graphic Symbole	Max. Flow U.S.GPM													
																	
				Working Pressure PSI				Working Pressure PSI				Working Pressure PSI					
				1450	2320	3630	4570	1450	2320	3630	4570	1450	2320	3630	4570		
Three Positions	Spring Centred	DSG-03-3C2		26.4	26.4	26.4	26.4	26.4 (18.5)	26.4 (12.7)	25.4 (7.4)	17.2 (6.3)	26.4 (18.5)	26.4 (12.7)	25.4 (7.4)	17.2 (6.3)		
		DSG-03-3C3		23.8	23.8	23.8	23.8	26.4 (21.4)	26.4 (21.4)	26.4 (21.4)	26.4 (21.4)	26.4 (21.4)	26.4 (21.4)	26.4 (21.4)	26.4 (21.4)	26.4 (21.4)	
		DSG-03-3C4		21.1	21.1	21.1 (17.2)	21.1 (6.6)	26.4 (15.3)	26.4 (8.7)	20.1 (5.8)	12.2 (5.0)	26.4 (15.3)	26.4 (8.7)	20.1 (5.8)	12.2 (5.0)	19.8 (5.3)	7.9 (4.0)
		DSG-03-3C40		26.4	26.4	26.4	26.4 (19.8)	26.4 (16.4)	26.4 (10.3)	22.2 (5.5)	12.7 (4.8)	26.4 (16.4)	26.4 (10.3)	22.2 (5.5)	12.7 (4.8)	26.4 (6.6)	16.4 (10.6)
		DSG-03-3C5		7.9	7.9	7.9	7.9	6.9	5.5	4.8	4.2	7.9	7.4	7.4	7.4	7.4	
		DSG-03-3C60		18.5	18.5	18.5	—	26.4	26.4	26.4	—	26.4	26.4	26.4	—	—	
		DSG-03-3C9		26.4	26.4	26.4	26.4	15.9	15.9	15.9	15.9	15.9	15.9	15.9	15.9	15.9	15.9
		DSG-03-3C10		21.1	21.1	21.1 (7.9)	21.1 (5.3)	26.4 (14.5)	26.4 (9.5)	15.9 (5.5)	9.0 (4.2)	26.4 (14.5)	26.4 (9.5)	15.9 (5.5)	9.0 (4.2)	7.9 (6.6)	5.3 (4.0)
		DSG-03-3C11		26.4	26.4	26.4	26.4	26.4 (21.1)	26.4 (17.2)	22.5 (9.2)	16.4 (7.4)	26.4 (21.1)	26.4 (17.2)	22.5 (9.2)	16.4 (7.4)	21.1 (15.9)	18.5 (12.2)
		DSG-03-3C12		23.8	23.8	23.8 (7.9)	23.8 (5.3)	26.4 (14.5)	26.4 (9.5)	15.9 (5.5)	9.0 (4.2)	26.4 (14.5)	26.4 (9.5)	15.9 (5.5)	9.0 (4.2)	10.6 (5.3)	5.3 (4.0)
Two Positions	No-Spring Detented	DSG-03-2D2		26.4	26.4	26.4	26.4	10.6	10.6	7.9	7.4	15.9	15.9	10.6	9.2		
	Spring Offset	DSG-03-2B2		26.4	26.4	26.4	26.4	9.0	6.3	5.3	5.0	26.4 (16.4)	26.4 (16.4)	26.4 (11.6)	24.8 (9.8)		
		DSG-03-2B3		26.4	26.4	26.4	26.4	15.1	15.1	15.1	15.1	26.4 (20.9)	26.4 (19)	26.4 (16.9)	26.4 (15.6)		
		DSG-03-2B8		—	—	—	—	6.9	5.0	4.8	4.2	26.4 (9.2)	23 (4.0)	16.1 (2.4)	12.9 (1.8)		

Notes: 1. The relation between the maximum flow in the table above and the voltage (within the serviceable voltage) is as shown below.

(Example)

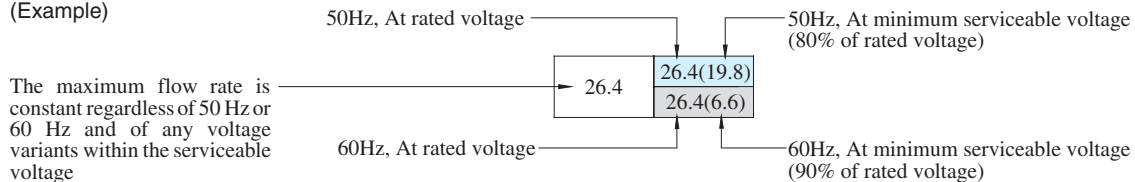





2. For the maximum flow rate in P → T of the valves with a ★ mark, please see page 368.

The valve models with a ◆ mark are handled as Options. If you choose such valves, check the time of delivery beforehand.

■ List of Standard Models and The Maximum Flow

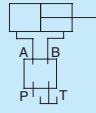
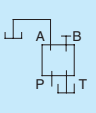
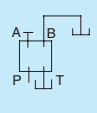
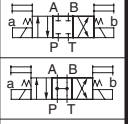
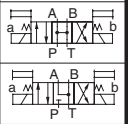
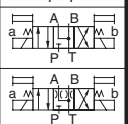
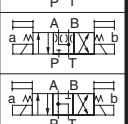
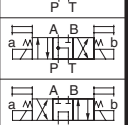
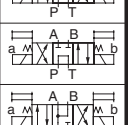
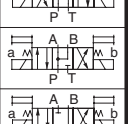
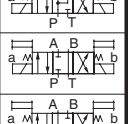
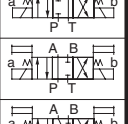
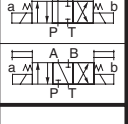
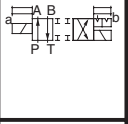
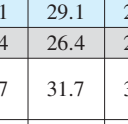
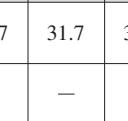
- Models with DC Solenoids: DSG-03-***-D*
- Models with R Type Solenoids: DSG-03-***-R*
- Models with RQ Type Solenoids: DSG-03-***-RQ100*

No. of Valve Positions	Spool-Spring Arrangement	Model Numbers	Graphic Symbols	Max. Flow U.S. GPM											
								 [Port "B" Blocked]				 [Port "A" Blocked]			
															
				Working Pressure PSI				Working Pressure PSI				Working Pressure PSI			
				1450	2320	3630	4570	1450	2320	3630	4570	1450	2320	3630	4570
Three Positions	Spring Centred	DSG-03-3C2		31.7	31.7	31.7	31.7	31.7	31.7	21.1	14.5	31.7	31.7	21.1	14.5
		DSG-03-3C3		31.7	31.7	31.7	31.7	31.7	31.7	31.7	31.7	31.7	31.7	31.7	31.7
		DSG-03-3C4		31.7	31.7	31.7	31.7	31.7	31.7	22.2	16.9	31.7	31.7	22.2	16.9
		DSG-03-3C40		31.7	31.7	31.7	31.7	31.7	31.7	16.4	12.9	31.7	31.7	16.4	12.9
		DSG-03-3C5		13.2	13.2	13.2	13.2	9.2	6.3	5.5	5.3	11.9	11.9	11.9	11.9
		DSG-03-3C60		31.7	31.7	31.7	—	31.7	31.7	31.7	—	31.7	31.7	31.7	—
		DSG-03-3C9		31.7	31.7	31.7	31.7	26.4	26.4	26.4	26.4	26.4	26.4	26.4	26.4
		DSG-03-3C10		31.7	31.7	31.7	17.2	31.7	29.6	15.9	13.5	31.7	29.6	15.9	13.5
		DSG-03-3C11		31.7	31.7	31.7	31.7	26.4	26.4	21.1	17.2	26.4	26.4	21.1	17.2
		DSG-03-3C12		31.7	31.7	31.7	17.2	31.7	31.7	16.4	13.5	31.7	31.7	16.4	13.5
Two Positions	No-Spring Detented	DSG-03-2D2		31.7	31.7	31.7	31.7	11.9	9.8	7.9	7.4	15.9	15.9	10.6	9.2
	Spring Offset	DSG-03-2B2		29.1	29.1	29.1	29.1	18	12.4	10	10	31.7	30.1	19.8	16.6
		DSG-03-2B3		31.7	31.7	31.7	31.7	20.3	20.3	20.3	20.3	31.7	31.7	31.7	27.2
		DSG-03-2B8		—	—	—	—	14	8.7	6.3	6.1	31.7	31.7	16.4	12.4

Notes) 1. The relation between the maximum flow in the table above and the voltage (within the serviceable voltage) is as shown below.

(Example)

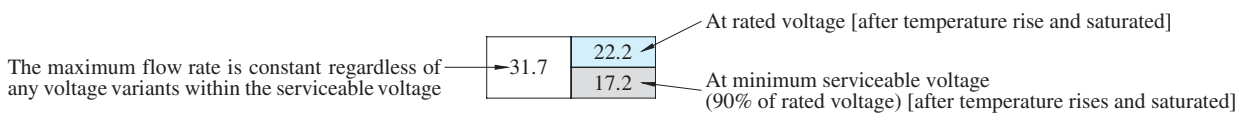

2. For the maximum flow rate in P → T of the valves with a ★ mark, please see [page 368](#).

The valve models with a ◆ mark are handled as Options. If you choose such valves, check the time of delivery beforehand.

DSG-03 Series Solenoid Operated Directional Valves

Maximum Flow of Centre By-Pass

In valve type 3C3, 3C5 and 3C60, in case where the actuator is put on in between the cylinder ports A and B as illustrated below and where the actuator moves and suspended at its stroke end and where the valve is then shifted to the neutral position in the suspended state of the actuator, the maximum flow rates available are those as shown as the table below regardless of any voltage in the range of serviceable voltage.

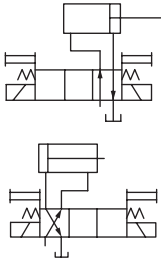

Model Numbers	Graphic Symbols	Max. Flow L/min (U.S.GPM)			
		10 MPa (1450 PSI)	16 MPa (2320 PSI)	25 MPa (3630 PSI)	31.5 MPa (4570 PSI)
DSG-03-3C3-A*		100 (26.4)	100 (26.4)	100 (26.4)	100 (26.4)
DSG-03-3C3-D*/R*/RQ100		120 (31.7)	120 (31.7)	120 (31.7)	120 (31.7)
DSG-03-3C5-A*		26 (6.9)	21 (5.5)	18 (4.8)	16 (4.2)
DSG-03-3C5-D*/R*/RQ100		35 (9.2)	24 (6.3)	21 (5.5)	20 (5.3)
DSG-03-3C60-A*		84 (22.2)	52 (13.7)	52 (13.7)	—
DSG-03-3C60-D*/R*/RQ100		68 (18.0)	65 (17.2)	61 (16.1)	—

List of Shockless Models and The Maximum Flow

- Models with DC Solenoids: S-DSG-03-***-D*
- Models with R Type Solenoids: S-DSG-03-***-R*
- Models with RQ Type Solenoids: S-DSG-03-***-RQ100

No. of Valve Positions	Spool-Spring Arrangement	Model Numbers	Graphic Symbols	Max. Flow L/min (U.S.GPM)											
								P → A [Port "B" Blocked]				P → B [Port "A" Blocked]			
				Working Pressure MPa (PSI)				Working Pressure MPa (PSI)				Working Pressure MPa (PSI)			
				5 (730)	10 (1450)	16 (2320)	25 (3630)	5 (730)	10 (1450)	16 (2320)	25 (3630)	5 (730)	10 (1450)	16 (2320)	25 (3630)
Three Positions	Spring Centred	S-DSG-03-3C2		120 (31.7)	120 (31.7)	120 (31.7)	120 (31.7)	120 (31.7)	120 (31.7)	75 (19.8)	50 (13.2)	120 (31.7)	120 (31.7)	75 (19.8)	50 (13.2)
		S-DSG-03-3C4		120 (31.7)	120 (31.7)	85 (22.5)	65 (17.2)	120 (31.7)	120 (31.7)	75 (19.8)	40 (10.6)	120 (31.7)	120 (31.7)	75 (19.8)	40 (10.6)
Two Positions	Spring Offset	S-DSG-03-2B2		120 (31.7)	100 (26.4)	75 (19.8)	40 (10.6)	39 (10.3)	39 (10.3)	39 (10.3)	39 (10.3)	120 (31.7)	120 (31.7)	105 (27.7)	60 (15.9)
														80 (21.1)	50 (13.2)

Note: The relation between the maximum flow in the table above and the voltage (within the serviceable voltage) is as shown below.

(Example)

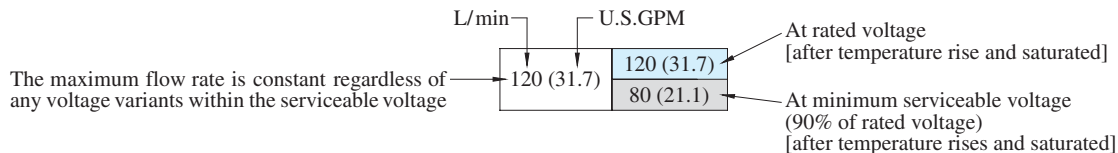

Reverse Mounting of Solenoid

In spring offset type, it is a standard configuration that the solenoid is mounted onto the valve in the SOL b position (side). However, in this particular spool-spring arrangement, the mounting of the solenoid onto the valve in the reverse position -SOL a side- is also available. The graphic symbol for this reverse mounting is as shown below. As for the valve type 2B*A and 2B*B, please refer to the explanation under the heading of "Valves Using Neutral Position and Side Position" given below.

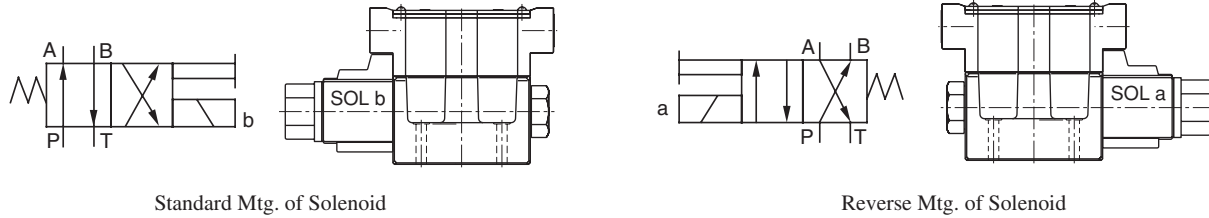

Valves Using Neutral Position and Side Position (Special Two Position Valve)

Besides the use of the standard 2-position valves aforementioned in the "List of Standard Models and Maximum Flow", the 3-position valves also can be used as the 2-position valves using the two of their three positions. In this case, there are two kinds of the valve available. One is the valve using the neutral position and SOL a position (2B*A) and another is the valve using the neutral position and SOL b position (2B*B).

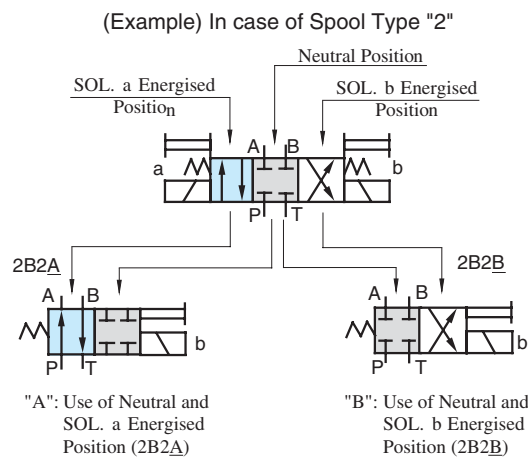

Model Numbers	Graphic Symbols	
	Standard Mtg. Type	Reverse Mtg. Type
(S-) DSG-03-2B*A		
(S-) DSG-03-2B2A		—

Model Numbers	Graphic Symbols	
	Standard Mtg. Type	Reverse Mtg. Type
DSG-03-2B*B		
(S-) DSG-03-2B2B		
DSG-03-2B3B		—
(S-) DSG-03-2B4B		—
DSG-03-2B60B		—
DSG-03-2B10B		—

In the above table, the graphic symbols in mounting type highlighted with shade are optional extra, therefore, please confirm the time of delivery with us before ordering.

E
DSG-03 Series Solenoid Operated Directional Valves

■ Typical Changeover Time

Changeover time varies according to oil viscosity, spool type and hydraulic circuit.

● **Standard Type** (Without Shockless Function)

[Test Conditions]

Pressure: 16 MPa (2320 PSI)
 Flow Rate: 70 L/min (18.5 U.S.GPM)
 Viscosity: 30 mm²/s (140 SSU)
 Voltage: 100 %V (After coil temperature rises and saturated)

[Result of Measurement]

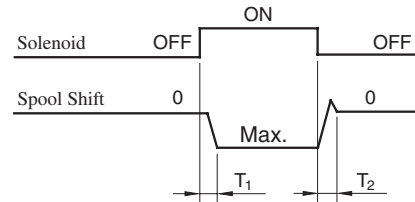

Type	Model Numbers	Changeover Time ms	
		T ₁	T ₂
Standard Type	DSG-03-3C2-A*	27	22
	DSG-03-3C2-D*	97	30
	DSG-03-3C2-R*	97	204
	DSG-03-3C2-RQ100	97	41

● **Shockless Type**

[Test Circuit and Conditions]

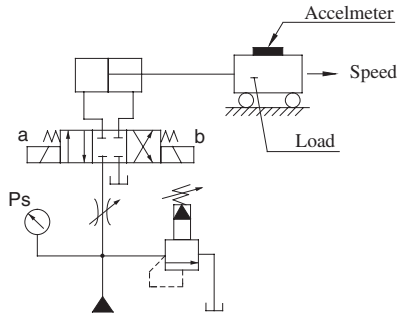

Setting Pressure (Ps): 7 MPa (1020 PSI)
 Load (W): 1000 kg (2205 lbs.)
 Speed: 8.8 m/min (28.9 ft./min)
 Viscosity: 30 mm²/s (140 SSU)

[Result of Measurement]

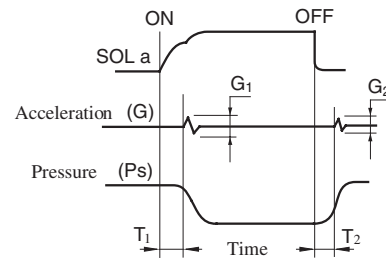

Type	Model Numbers	Time ms		Acceleration m/s ² (G)	
		T ₁	T ₂	G ₁	G ₂
Shockless Type	S-DSG-03-3C2-D*	110	120	6.4	6.4
	S-DSG-03-3C2-R*	110	220	(.65)	(.65)
	S-DSG-03-3C2-RQ100	110	120		

Pressure Drop

Pressure drop curves based on viscosity of 35 mm²/s (164 SSU) and specific gravity of 0.850.

Standard Type: DSG-03

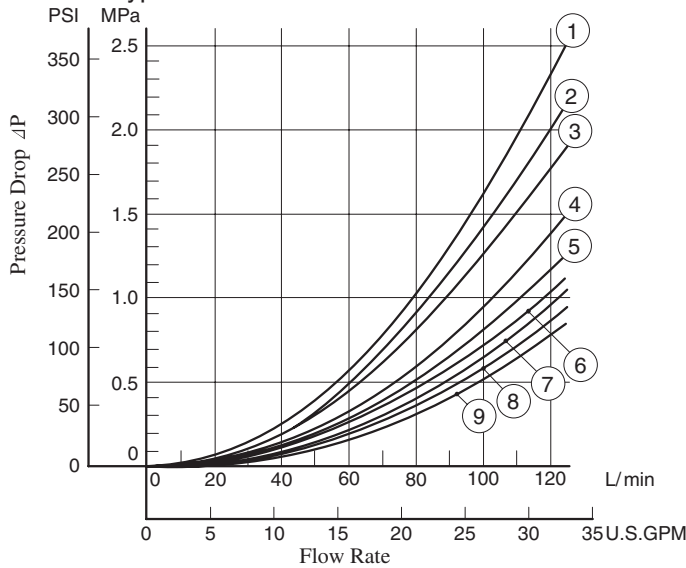

Model Numbers	Pressure Drop Curve Number				
	P→A	B→T	P→B	A→T	P→T
DSG-03-3C2	⑦	⑦	⑦	⑦	—
DSG-03-3C3	⑨	⑨	⑨	⑨	⑤
DSG-03-3C4	⑦	⑧	⑦	⑧	—
DSG-03-3C40	⑦	⑦	⑦	⑦	—
DSG-03-3C5	⑨	⑦	⑦	⑨	①
DSG-03-3C60	⑥	⑤	⑥	⑤	①
DSG-03-3C9	⑨	⑦	⑨	⑦	—
DSG-03-3C10	⑦	⑧	⑦	⑦	—
DSG-03-3C11	⑨	⑦	⑦	⑦	—
DSG-03-3C12	⑦	⑦	⑦	⑧	—
DSG-03-2D2	④	③	⑥	⑥	—
DSG-03-2B2	②	①	⑦	⑦	—
DSG-03-2B3	③	②	⑨	⑨	—
DSG-03-2B8	⑥	—	⑤	—	—

Shockless Type: S-DSG-03

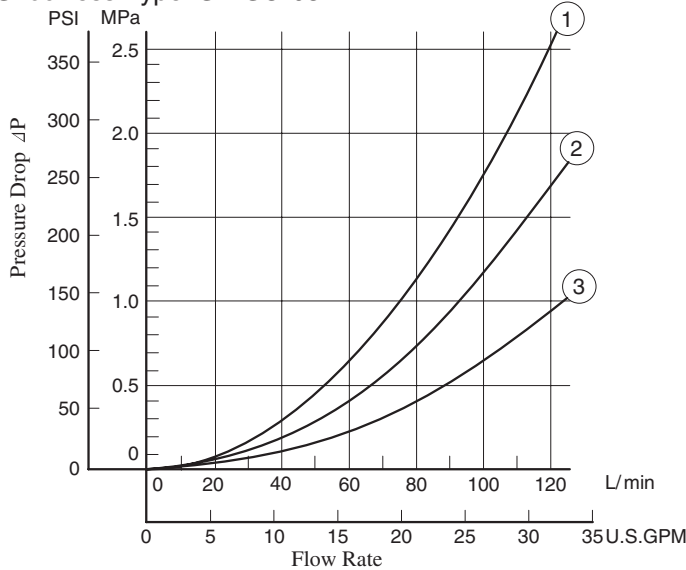

Model Numbers	Pressure Drop Curve Number			
	P→A	B→T	P→B	A→T
S-DSG-03-3C2	②	②	②	②
S-DSG-03-3C4	②	②	③	③
S-DSG-03-2B2	①	②	②	②

● For any other viscosity, multiply the factors in the table below.

Viscosity	mm ² /s	15	20	30	40	50	60	70	80	90	100
	SSU		77	98	141	186	232	278	324	371	417
Factor		0.81	0.87	0.96	1.03	1.09	1.14	1.19	1.23	1.27	1.30

● For any other specific gravity (G'), the pressure drop (ΔP') may be obtained from the formula below.

$$\Delta P' = \Delta P (G'/0.850)$$

F
DSG-03 Series Solenoid Operated Directional Valves

TERMINAL BOX TYPE

- Models with AC Solenoids: DSG-03- ***-A* -50/5090
- Double Solenoid: Spring Centred & No-Spring Detended

Model Numbers	"C" Thd.
DSG-03- ***-A* -50	G 1/2
DSG-03- ***-A* -5090	1/2 NPT

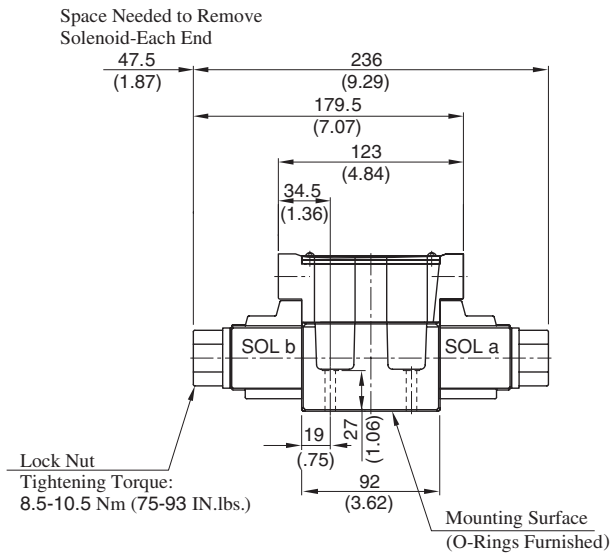
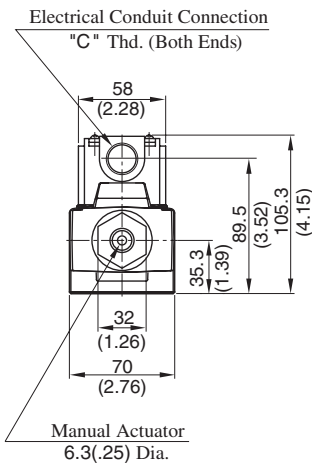
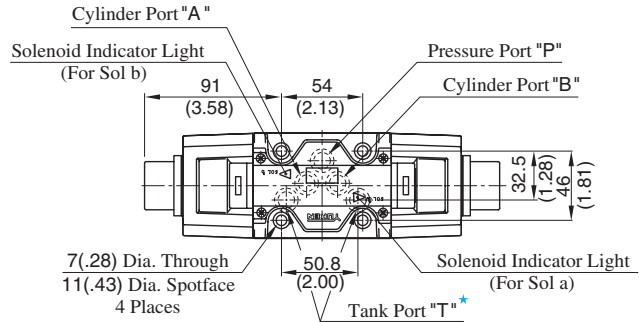

★. Of the two of tank port "T", the tank port in the left side is normally used in our standard sub-plate, though, either side of the tank port "T" can be used without problem.

DIMENSIONS IN MILLIMETRES (INCHES)

- Single Solenoid: Spring Offset

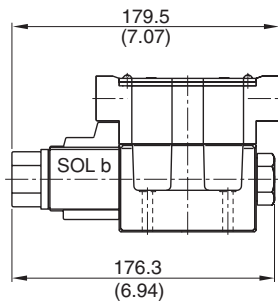

- For other dimensions, refer to "Spring Centred and No-Spring Detended" models.
- Solenoid being mounted in the reverse position -SOL a side- is also available.

Mounting surface: ISO 4401-AC-05-4-A

TERMINAL BOX TYPE

- Models with DC Solenoids : (S-)DSG-03- *** -D* -50/5090
- Models with R Type Solenoids : (S-)DSG-03- *** -R* -50/5090
- Models with RQ Type Solenoids : (S-)DSG-03- *** -RQ100-50/5090
- Double Solenoid: Spring Centred & No-Spring Detented
- Single Solenoid: Spring Offset

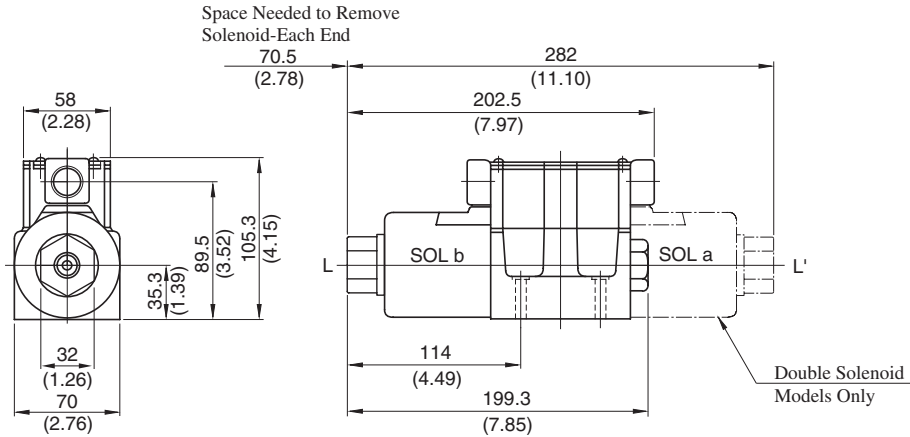

● For other dimensions, refer to Models with AC solenoids (Page 372).

DIMENSIONS IN
MILLIMETRES (INCHES)

Sub- plates

DSGM-03*-40/2180/2190

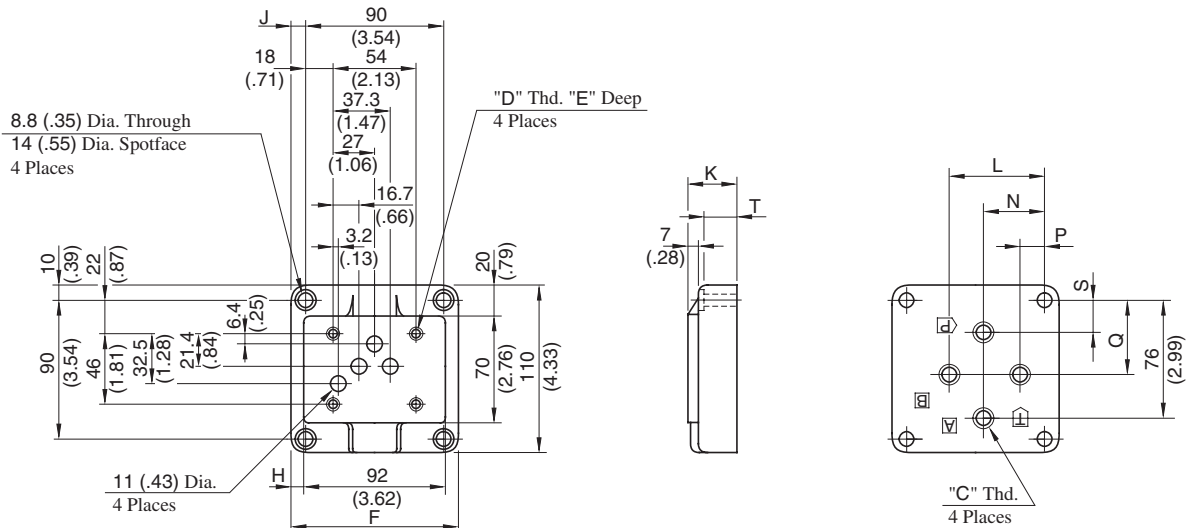

Sub-plate Model Numbers	Piping Size "C" Thd.	"D" Thd.	Dimensions mm (Inches)										
			E	F	H	J	K	L	N	P	Q	S	T
DSGM-03-40	Rc 3/8	M6	13 (.51)	110	9	10	32	62	40	16	48	21	24
DSGM-03-2180	3/8 BSP.F		(4.33)	(.35)	(.39)	(1.26)	(2.44)	(1.57)	(.63)	(1.89)	(.83)	(.94)	
DSGM-03-2190	3/8 NPT		1/4-20 UNC	15 (.59)									
DSGM-03X-40	Rc 1/2	M6	13 (.51)	110	9	10	32	62	40	16	48	21	24
DSGM-03X-2180	1/2 BSP.F		(4.33)	(.35)	(.39)	(1.26)	(2.44)	(1.57)	(.63)	(1.89)	(.83)	(.94)	
DSGM-03X-2190	1/2 NPT		1/4-20 UNC	15 (.59)									
DSGM-03Y-40	Rc 3/4	M6	13 (.51)	120	14	15	50	80	45	10	47	16	42
DSGM-03Y-2180	3/4 BSP.F		(4.72)	(.55)	(.59)	(1.97)	(3.15)	(1.77)	(.39)	(1.85)	(.63)	(1.65)	
DSGM-03Y-2190	3/4 NPT		1/4-20 UNC	15 (.59)									

■ **PLUG-IN CONNECTOR TYPE (N)**
PLUG-IN CONNECTOR WITH INDICATOR LIGHT (N1)

● **Models with AC Solenoids: DSG-03- *** -A* - $\frac{N}{N1}$ -50/5090**

The position of the Plug-in connector can be changed as illustrated below by loosening the lock nut. After completion of the change, be sure to tighten the lock nut with the torque as specified below.

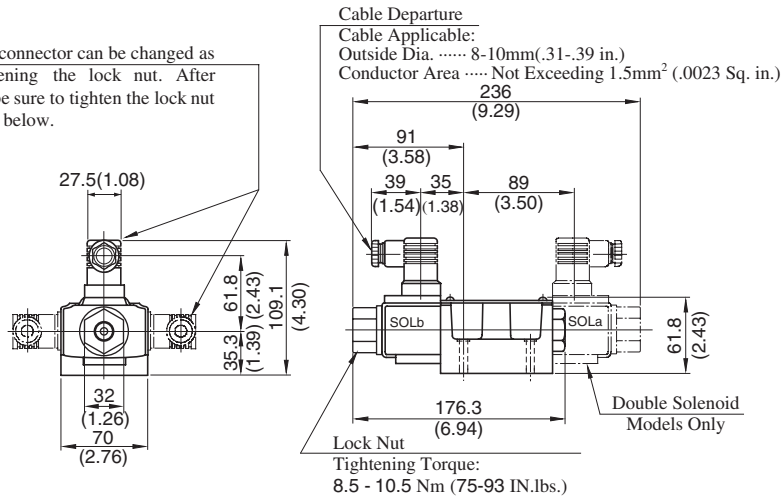

● **Models with DC Solenoids: (S-)DSG-03- *** -D* - $\frac{N}{N1}$ -50/5090**

● **Models with R Type Solenoids: (S-)DSG-03- *** -R* -N-50/5090**

The position of the Plug-in connector can be changed as illustrated below by loosening the lock nut. After completion of the change, be sure to tighten the lock nut with the torque as specified below.

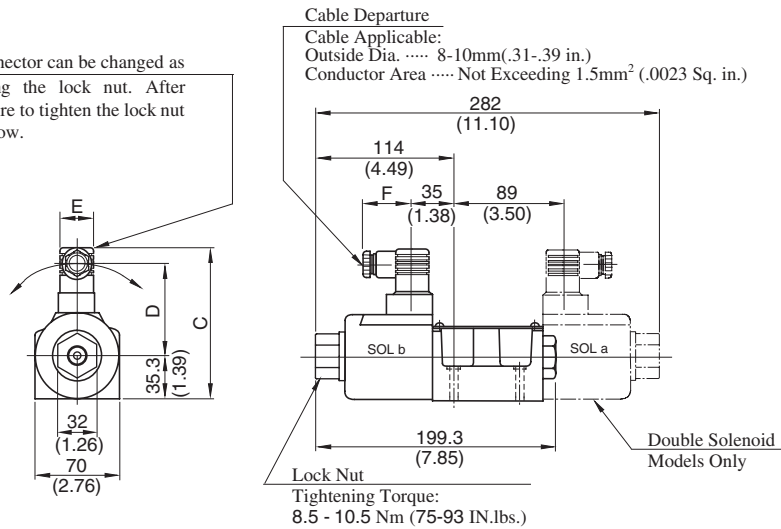

Model Numbers	Dimensions mm (Inches)			
	C	D	E	F
DSG-03- *** -D* - $\frac{N}{N1}$ -50/5090	121.1 (4.77)	73.8 (2.91)	27.5 (1.08)	39 (1.54)
DSG-03- *** -R* -N-50/5090	124.9 (4.92)	62.6 (2.46)	34 (1.34)	53 (2.09)

● For other dimensions, refer to "Terminal Box Type" (Page 372 – 373).

DIMENSIONS IN MILLIMETRES (INCHES)

■ **Options**

Models with Push Button & Lock Nut: (S-)DSG-03- * -*C(- $\frac{N}{N1}$)-50/5090**

Lock Nut
 Press the "Push Button" then turn "Lock Nut" clockwise. The position of the "Push Button" is held.
 Be sure to loosen "LockNut" fully before solenoid is energised

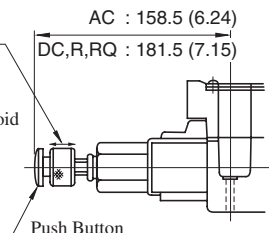

Details of Receptacle

Type of Electrical Conduit Connection	Double Solenoid Type	Single Solenoid Type
Terminal Box Type	<p>Diagram showing a double solenoid valve with two solenoids (SOL. a and SOL. b) and an indicator light. It includes terminals for Power Supply (For SOL. b), Earth, Common Plate, Common, and Earth. A note indicates that there are two grounding terminals and that the common plate can be removed if not needed.</p>	<p>Diagram showing a single solenoid valve with one solenoid (SOL. b) and an indicator light. It includes terminals for Earth and Power Supply.</p>
Plug-in Connector Type	<p>Diagram showing a plug-in connector with terminals for 1-Power Supply, Ground, and 2-Power Supply.</p>	

- ★1. There are two grounding terminals. You can use either one.
- ★2. If you do not need the common plate, remove it.
- ★3. With DC solenoids, polarity is no question.

⚠ DANGER

- Do not perform wiring while the power is on. Doing so may result in electric shock, burns or death.
- Make the wiring properly. Improper wiring will cause an irregular movement of the machine, resulting in a grave accident.

Electrical Circuit

Type of Electrical Conduit Connection	Electric Source		
	AC	DC	AC→DC Rectified
Terminal Box Type	<p>AC circuit diagram showing Power Supply, Indicator Light, Common, and Ground connected to the SOL. coil.</p>	<p>DC circuit diagram showing Power Supply, Indicator Light, Common, and Ground connected to the SOL. coil, with a Voltage-Surge Suppressor in parallel with the coil.</p>	<p>AC→DC Rectified circuit diagram showing Power Supply, Indicator Light, Voltage-Surge Suppressor, Rectifier Circuit, Common, and Ground connected to the SOL. coil.</p>
Plug-in Connector Type	<p>AC circuit diagram showing 1-Power Supply, Indicator Light (Integrated in "N1" model only), Common, and Ground connected to the SOL. coil.</p>	<p>DC circuit diagram showing 1-Power Supply, Indicator Light (Integrated in "N1" model only), 2-Power Supply, Common, and Ground connected to the SOL. coil, with a Voltage-Surge Suppressor (Circuit composed in coil) in parallel with the coil.</p>	<p>AC→DC Rectified circuit diagram showing 1-Power Supply, Voltage-Surge Suppressor, 2-Power Supply, Rectifier Circuit, Common, and Ground connected to the SOL. coil.</p>

■ List of Seals

*-DSG-03-***-*-50/5090

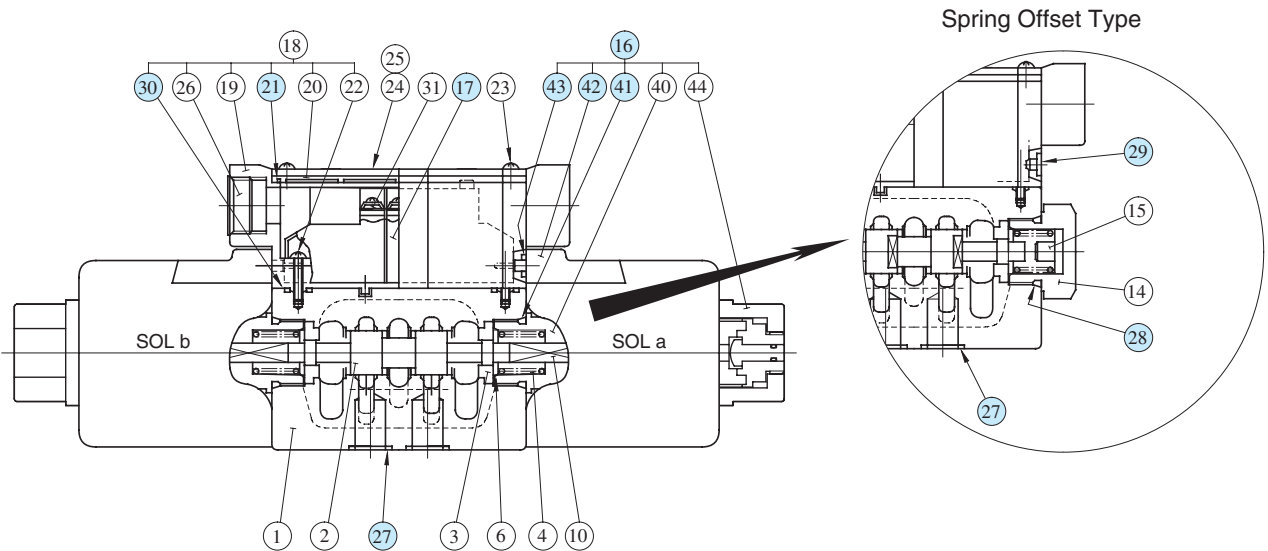

*-DSG-03-***-N/N1-50/5090

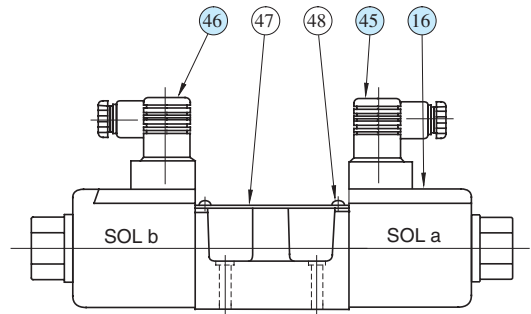

● List of Seals

Item	Name of Parts	Part Numbers	Qty.			Remarks
			3C	2D2	2B	
21	Gasket	1751S-VK418689-6	1	1	1	
27	O-Ring	SO-NB-A014(NBR, Hs90)	5	5	5	
28	O-Ring	SO-NB-P21	—	—	1	
29	Plug	1790S-VK418329-9	—	—	2	
30	O-Ring	S6	2	2	2	
41	O-Ring	SO-NB-P21	2	2	1	} Included in Solenoid Ass'y (Item 16)
43	O-Ring	SO-NA-P4	4	4	2	

★ When ordering the O-Rings, please specify the seal kit number from the table below.

Valve Model Numbers	Seal Kit No.	O-Ring Details for Seal Kit
DSG-03-***-*-50/5090	KS-DSG-03-50	27(5 Pcs.), 28 & 41(2 Pcs., see above), 43(4 Pcs.)
DSG-03-***-*-N-50/5090	KS-DSG-03-N-50	27(5 Pcs.), 28 & 41(2 Pcs., see above)

● Solenoid Ass'y, Coil, Receptacle and Connector

Refer to Page 377 for the details of these parts.

Solenoid Ass'y, Coil, Receptacle and Connector Ass'y No.

Valve Model Numbers	⑩ Solenoid Ass'y No.	④② Coil No.	⑰ Receptacle Part No.	④⑤ Connector Ass'y Part No.	④⑥ Connector Ass'y Part No.	Remarks
DSG-03-***-A100-50*	SA3-100-51	C-SA3-100-51	R3-60	—	—	Terminal Box Type
DSG-03-***-A120-50*	SA3-120-51	C-SA3-120-51				
DSG-03-***-A200-50*	SA3-200-51	C-SA3-200-51				
DSG-03-***-A240-50*	SA3-240-51	C-SA3-240-51				
DSG-03-***-D12-50*	SD3-12-51	C-SD3-12-51	KR3-A-60			
DSG-03-***-D24-50*	SD3-24-51	C-SD3-24-51	KR3-C-60			
DSG-03-***-D100-50*	SD3-100-51	C-SD3-100-51				
DSG-03-***-R100-50*	SR3-100-51	C-SR3-100-51	RR3-60			
DSG-03-***-R200-50*	SR3-200-51	C-SR3-200-51	QR3-C-60			
DSG-03-***-RQ100-50*	SR3-100-51	C-SR3-100-51				
S-DSG-03-***-D12-50*	SD3-12-S-51	C-SD3-12-51	KR3-A-60			
S-DSG-03-***-D24-50*	SD3-24-S-51	C-SD3-24-51	KR3-C-60			
S-DSG-03-***-D100-50*	SD3-100-S-51	C-SD3-100-51				
S-DSG-03-***-R100-50*	SR3-100-S-51	C-SR3-100-51	RR3-60			
S-DSG-03-***-R200-50*	SR3-200-S-51	C-SR3-200-51	QR3-C-60			
S-DSG-03-***-RQ100-50*	SR3-100-51	C-SR3-100-51				
DSG-03-***-A100-N-50*	SA3-100-N-51	C-SA3-100-N-51	—	GDM-211-A-11	GDM-211-B-11	Plug-in Connector Type
DSG-03-***-A120-N-50*	SA3-120-N-51	C-SA3-120-N-51				
DSG-03-***-A200-N-50*	SA3-200-N-51	C-SA3-200-N-51				
DSG-03-***-A240-N-50*	SA3-240-N-51	C-SA3-240-N-51				
DSG-03-***-D12-N-50*	SD3-12-N-51	C-SD3-12-N-51				
DSG-03-***-D24-N-50*	SD3-24-N-51	C-SD3-24-N-51				
DSG-03-***-D100-N-50*	SD3-100-N-51	C-SD3-100-N-51				
DSG-03-***-R100-N-50*	SR3-100-N-51	C-SR3-100-N-51				
DSG-03-***-R200-N-50*	SR3-200-N-51	C-SR3-200-N-51		GDME-211-R-A-10	GDME-211-R-B-10	
S-DSG-03-***-D12-N-50*	SD3-12-S-N-51	C-SD3-12-N-51		GDM-211-A-11	GDM-211-B-11	
S-DSG-03-***-D24-N-50*	SD3-24-S-N-51	C-SD3-24-N-51				
S-DSG-03-***-D100-N-50*	SD3-100-S-N-51	C-SD3-100-N-51		GDME-211-R-A-10	GDME-211-R-B-10	
S-DSG-03-***-R100-N-50*	SR3-100-S-N-51	C-SR3-100-N-51				
S-DSG-03-***-R200-N-50*	SR3-200-S-N-51	C-SR3-200-N-51		GDM-211-A-11	GDM-211-B-11	Plug-in Connector with Indicator Light
DSG-03-***-A100-N1-50*	SA3-100-N-51	C-SA3-100-N-51				
DSG-03-***-A120-N1-50*	SA3-120-N-51	C-SA3-120-N-51				
DSG-03-***-A200-N1-50*	SA3-200-N-51	C-SA3-200-N-51				
DSG-03-***-A240-N1-50*	SA3-240-N-51	C-SA3-240-N-51				
DSG-03-***-D12-N1-50*	SD3-12-N-51	C-SD3-12-N-51				
DSG-03-***-D24-N1-50*	SD3-24-N-51	C-SD3-24-N-51				
DSG-03-***-D100-N1-50*	SD3-100-N-51	C-SD3-100-N-51				
S-DSG-03-***-D12-N1-50*	SD3-12-S-N-51	C-SD3-12-N-51				
S-DSG-03-***-D24-N1-50*	SD3-24-S-N-51	C-SD3-24-N-51				
S-DSG-03-***-D100-N1-50*	SD3-48-S-N-51	C-SD3-100-N-51				
S-DSG-03-***-D100-N1-50*	SD3-48-S-N-51	C-SD3-100-N-51				

Note : The connector assembly is not included in the solenoid assembly.

E

DSG-03 Series Solenoid Operated Directional Valves